

CATALOG

2019
1st edition

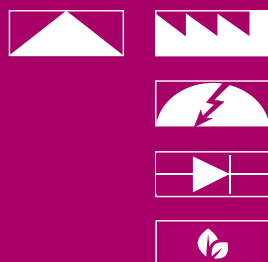

ELECTROTECHNICAL PRODUCTS

BUILDING AND INDUSTRY	1
ENERGY	2
SEMICONDUCTORS PROTECTION	3
GREEN PROTECT	4
BUSBAR TRUNKING SYSTEM	5
ETIPOWER	6
ETIBREAK	7
SOLID GSX ENCLOSURES SYSTEM	8



ETI

Power needs control



ETI d.o.o.
 Obrezija 5, 1411 Izlake,
 Slovenia
 Tel. +386/0/3 56 57 570
 eti@eti.si



Subsidiaries:

- **ETI Proplast**
 Obrezija 5, 1411 Izlake, Slovenia
 Tel. +386/0/3 56 57 590
 etiproplast@eti.si
- **ETI DE GmbH**
 Dorfwiesenweg 13,
 63828 Kleinkahl, Germany
 Tel. +49 6024 63 97 10
 contact@eti-de.de
- **ETI Polam Sp. z o.o.**
 Ul. Jana Pawla II 18,
 06100 Pultusk, Poland
 Tel. +48 23 691 9300
 etipolam@etipolam.com.pl
- **ETI Sarajevo d.o.o.**
 Hifzi Bjelevca 13, 71 000 Sarajevo,
 Bosnia and Herzegovina
 Tel. +387 33 77 52 50
 etisa@bih.net.ba
- **ETI Bulgaria**
 1309 Sofia, 205 Alexandar
 Stamboliyski Blvd, flor 1, office 27
 Telefon: +359/0/2 81 264 93
 office@eti.bg
- **ETI Ukraine**
 Ul. Akademika Tupoleva 19a, of. 201,
 04128 Kiev, Ukraine
 Tel. +380 44 494 21 80
 office@eti.ua
- **ETI Baltus, UAB**
 Tilzes 41 a, 47187 Kaunas, Lithuania
 Tel. +370 37 261 582
 info@etibaltus.lt
- **ETI B**
 Zvečanska 56/17
 11000 Beograd, Serbia Savski venac
 Tel. +381 11 3691 092
 etib@etib.rs
- **OOO ETI Elektroelement - Russia**
 115088, г. Москва, ул. Угрешская д. 2,
 строение 76, Moscow, Russia
 Tel. +7 495 665-34-80
 info@etirus.ru
- **ETI HU Elektrotechnikai, Kft.**
 Rokolya utca 25, 1131 Budapest,
 Hungary
 Tel. +36 1 238 0784
 eti@eti-hu.hu
- **ETI Romania Srl.**
 Strada Doina Nr.17
 Sector 5, 050707 Bucuresti, Romania
 Tel. 004 021 424 83 83
 eti.electrice@gmail.com
- **ETI Elektroelement CZ s.r.o.**
 P3 Logistics Parks, Budova F
 Paceařická 2773/1
 19300 Praha - Horní Počernice
 Tel. 00420 777 950 203
- **ETI Elektroelement d.o.o.**
 Ulica grada Vukovara 235/V,
 10000 Zagreb, Hrvatska
 Ured Trpanjska 7,
 Tel. 099 23 57 007
 zreiholz@etigroup.hr

Associated companies:

- **ITALWEBER S.p.A.**
 Via Enrico Fermi 40/42
 20090 Assago (MI) Italy
 Tel. +39/02/939 771
 info@italweber.it

SOLID GSX



2019

HXS standing enclosures (IP55/65)
with accessories and additional equipment



4XP160 flush mounted enclosures
(IP42/44)
4XN160 wall mounted enclosures
(IP41/42/44)
and internal construction system

2014

2015

GT hermetic enclosures
(IP66)

2012

GT hermetic enclosures (IP65)



SOLID GSX

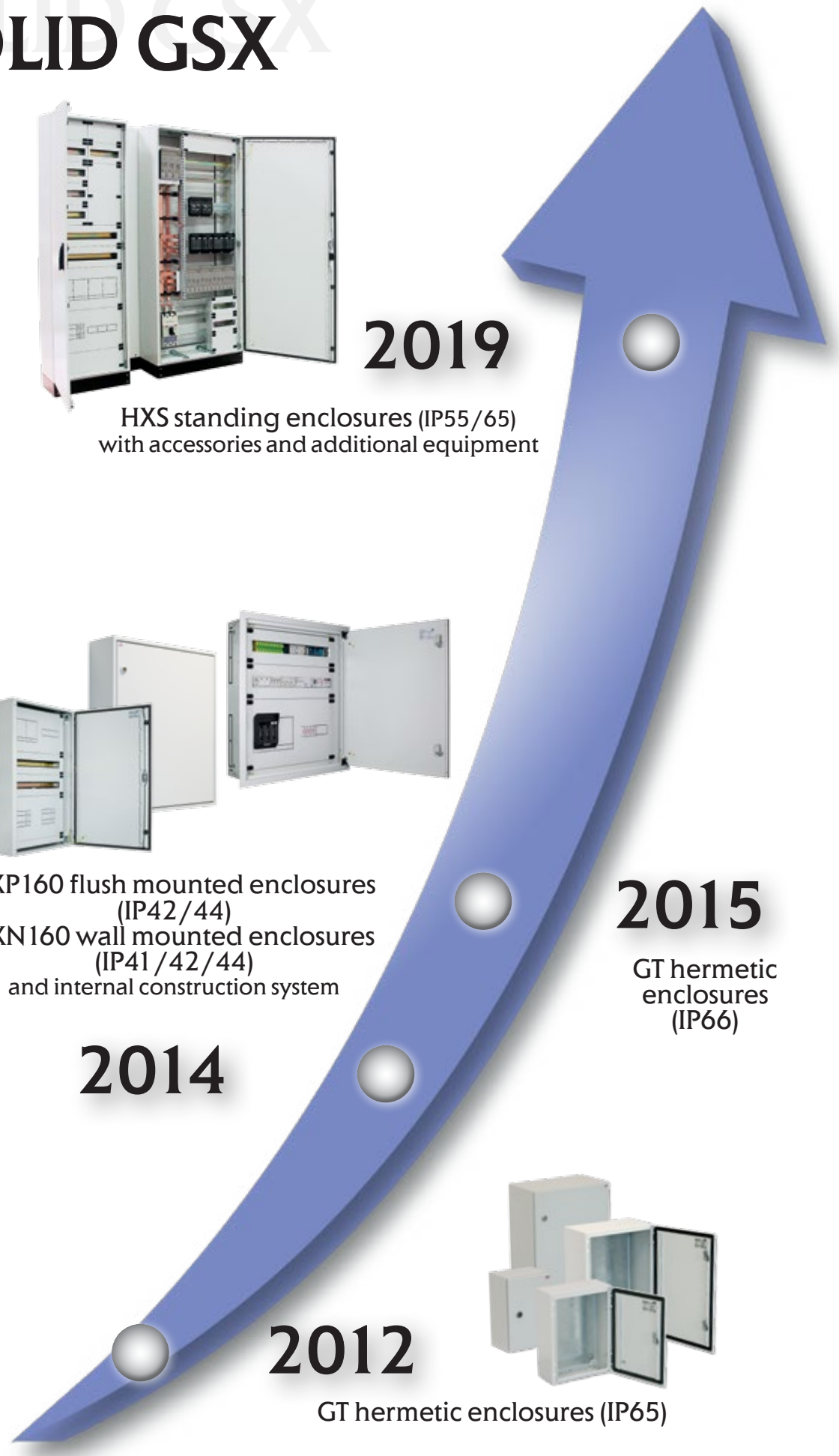

HXS STANDING ENCLOSURES (IP55, 65)



HXS STANDING ENCLOSURES (IP55, 65)

Application - HXS system standing enclosures of the SOLID GSX series are available in three standard widths (550 mm, 800 mm, 1050 mm) and a depth of 300 mm (enclosure 1850 mm high) and 400 mm (enclosure with a height of 2000 mm). The enclosures have possibility to be equipped with mounting plates, internal sets with electric equipment and a power distribution system based on busbars. Thanks to dedicated mounting holes and weaknesses in the side walls, it is possible to connect the enclosures into sets and carry out wiring or busbars between the sections. Enclosures can be attached to the wall using dedicated openings in the back of the enclosures or brackets intended for that purpose. It is also possible to attach the enclosures to the floor thanks to mounting holes in the plinths.

Technical data	
Protection class	I
Degree of protection	IP55,65
Mechanical strength	IK10
Rated current	1600 A (depending on the busbars used)
Colour	Enclosures body: light gray (RAL 7035) Plinth: black (RAL 9005)
Paint	Polyester
Application	Indoor enclosures
Operating temperature	-5°C ... +40°C
Standards	PN-IEC/EN 62208, PN-IEC/EN 60529, PN-IEC/EN 62262
Directives	RoHS

Mechanical load	
Internal set (WP-A / WP-U + LG-V + TH-S)	250 kg
Mounting plate (PM)	40 kg
Mounting plate (PM-G)	350 kg
Doors	10 kg

Advantages:

- High versatility and flexibility of configuration,
- Removable internal set (can be used in a workshop or in the building during installation),
- It is possible to divide the internal set vertically and horizontally,
- Covers and mounting plates dedicated to ETI equipment (circuit breakers, disconnectors, etc.),
- Quick assembly,
- Three-point door locking system with toothed mechanism and lever with the option of being equipped with a system or patent insert,
- Unscrewed rear wall with polyurethane poured gasket,
- High-quality diaphragm glands from the top and double aluminum from the bottom,
- A four-element plinth with a cable fixing beam. The plinths can be screwed together and combined to achieve the required height,
- Precision made of high quality powder coated steel sheet,
- Painted with polyester paint resistant to UV radiation.



Series of types of HXS enclosures and method of their marking

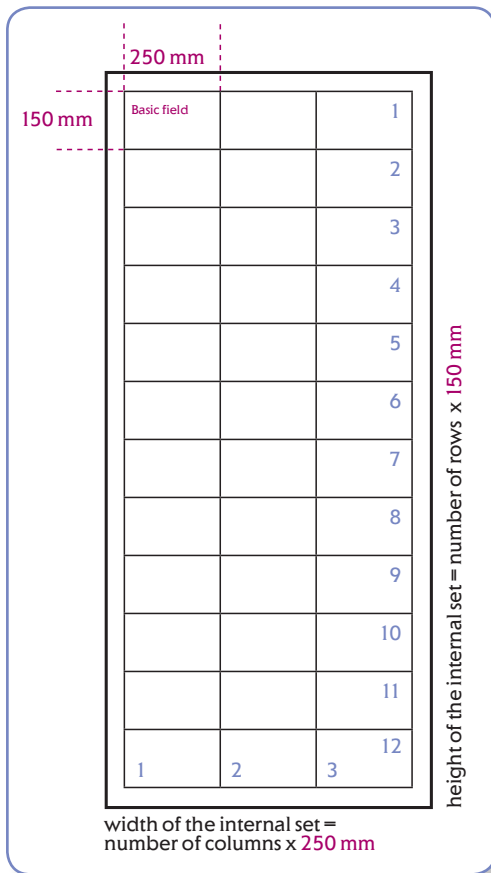

Overview Heights/Widths- Internal dividing for HXS enclosures

Range of sizes is based on DIN 43870 standard. Base module with devices cover has a width of 250 mm and a height of 150 mm. In this module you can install 12 modular devices with a width 18 mm. A code for the basic fields represent two digits separated by a dash of 1-1, where the first digit describes the width and the second height.

Other sizes multiplies the basic fields (eg. 2-3 cover mean- width 500 mm, height 450 mm).

HXS standing enclosures occur in three window widths 2, 3, 4 (500, 750 and 1000 mm), depths: 300 mm and 400 mm and heights: 12 (1800 mm) and 13 (1950 mm).

Enclosures with width 2 can be divided in vertical configuration 1 + 1.

The width of the enclosure 3 can be divided in the configuration of 1 + 1 + 1, 2 + 1 or 1 + 2.

And width 4 enclosures can be divided into 1 + 1 + 1 + 1, 2 + 2, 1 + 1 + 2 etc.

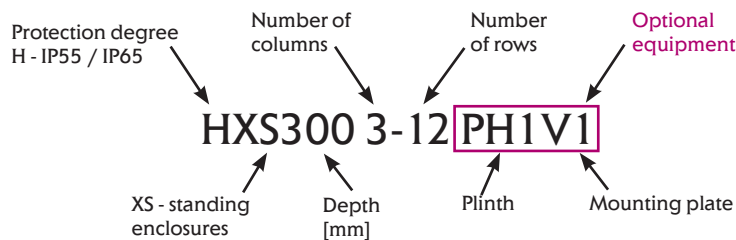

Enclosure types		External enclosure dimensions											
Type	Code no.	Degree of protection	Width (mm)	Height without plinth (mm)	Depth (mm)	Plinth (mm)	Mounting plate (mm)	Number of doors	The maximum number of modules (18 mm)	Maximum power loss P (W)	Weight (kg)	Packaging (pcs.)	
HXS300 series x-x PH1													
Empty standing enclosures with plinth - 300 mm of depth *													
HXS300 2-12 PH1	001325102	IP65	550	1850	300	100	-	1	12x24	288	251	54,81	1
HXS300 3-12 PH1	001325103	IP65	800	1850	300	100	-	1	12x36	432	328	70,25	1
HXS300 4-12 PH1	001325104	IP55	1050	1850	300	100	-	2	12x48	576	407	87,57	1
HXS300 series x-x PH1 V1													
Standing enclosures with mounting plate and plinth - 300 mm of depth *													
HXS300 2-12 PH1V1	001325502	IP65	550	1850	300	100	1x 500	1	12x24	288	251	70,36	1
HXS300 3-12 PH1V1	001325503	IP65	800	1850	300	100	1x 750	1	12x36	432	328	93,19	1
HXS300 4-12 PH1V1	001325504	IP55	1050	1850	300	100	1x 1000	2	12x48	576	407	124,83	1
HXS400 series x-x													
Empty standing enclosures without plinth - 400 mm of depth **													
HXS400 2-13	001327508	IP65	550	2000	400	-	-	1	13x24	312	306	65,53	1
HXS400 3-13	001327509	IP65	800	2000	400	-	-	1	13x36	468	395	82,14	1
HXS400 4-13	001327510	IP55	1050	2000	400	-	-	2	13x48	624	483	100,99	1

* Enclosures with a height of 12 (1850) and a depth of 300 mm are standard equipped with a plinth with a height of 100 mm,

** Enclosures with a height of 13 (2000) and a depth of 400 mm are not equipped as standard with a plinth (need to be ordered separately)

HXS300 2-12 PH1



Single door
Degree of protection IP65

HXS300 3-12 PH1



Single door
Degree of protection IP65

HXS300 4-12 PH1



Double door
Degree of protection IP55

Plinths for enclosures			External dimensions			Weight (kg)	Packaging (pcs.)
Type	Description	Code no.	Width (mm)	Height (mm)	Depth (mm)		
Plinths for 300 mm deep enclosures from the HXS300 series *							
PH1 D3-W2	Plinth 100 mm height and RAL9005 for HXS300 enclosures with width 2 (550)	001336910	550	100	300	3,49	1
PH1 D3-W3	Plinth 100 mm height and RAL9005 for HXS300 enclosures with width 3 (800)	001336912	800	100	300	4,38	1
PH1 D3-W4	Plinth 100 mm height and RAL9005 for HXS300 enclosures with width 4 (1050)	001336914	1050	100	300	5,24	1
Plinths for 400 mm deep enclosures from the HXS400 series **							
PH1 D4-W2	Plinth 100 mm height and RAL9005 for HXS400 enclosures with width 2 (550)	001336918	550	100	400	3,99	1
PH1 D4-W3	Plinth 100 mm height and RAL9005 for HXS400 enclosures with width 3 (800)	001336920	800	100	400	4,88	1
PH1 D4-W4	Plinth 100 mm height and RAL9005 for HXS400 enclosures with width 4 (1050)	001336922	1050	100	400	5,75	1

*Enclosures with a height of 12 (1850) and a depth of 300 mm are standard equipped with a plinth with a height of 100 mm,

**Enclosures with a height of 13 (2000) and a depth of 400 mm are not equipped as standard with a plinth (need to be ordered separately)



A four-element plinth
with a cable fixing bar

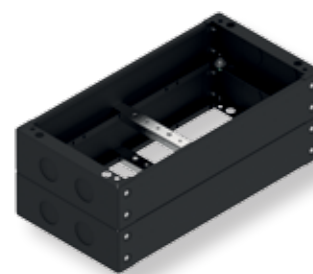

The plinths can be screwed together and
combined to achieve the required height,

HXS300 2-12 PH1 enclosure components (standard equipment)

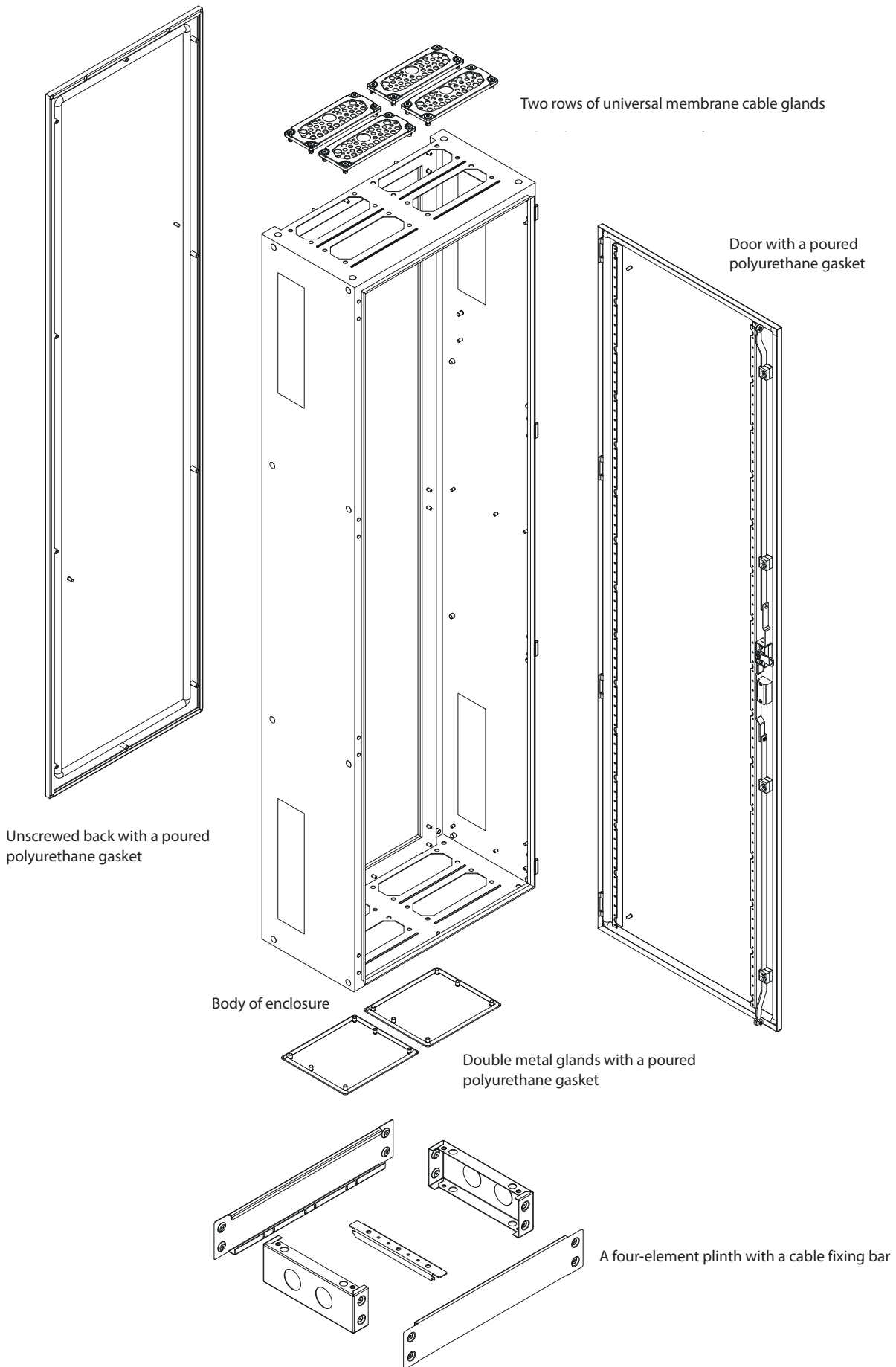

HXS400 2-13 enclosure components (standard equipment)

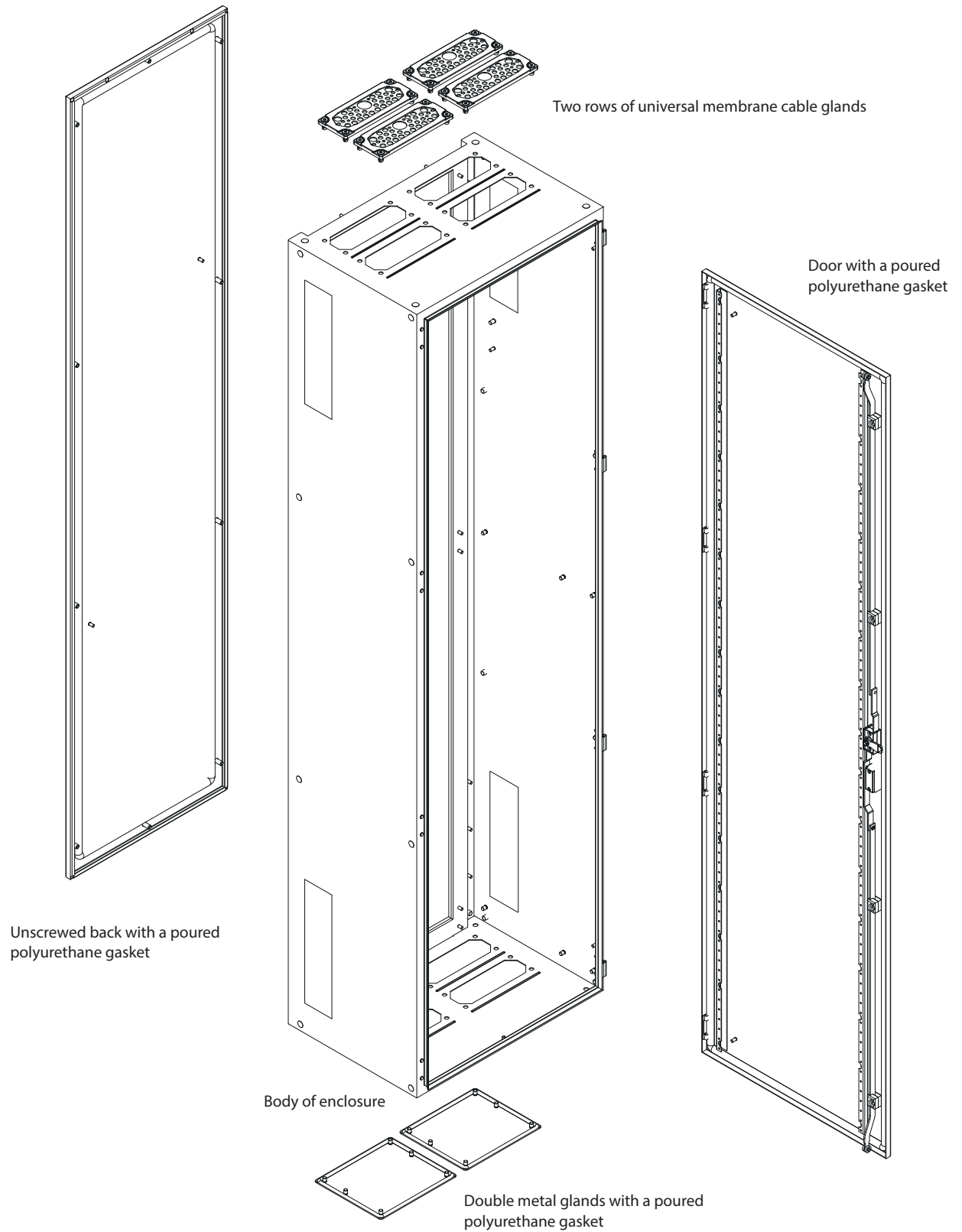

Advantages and technical characteristics:

Three-point locking system



The enclosures of the HXS series are equipped as standard with a three-point locking system with a toothed mechanism and a lever, which enables the installation of various types of system and patent inserts. The closing system is equipped with profiled bands embedded in independent gibs. At the ends of the bands, rollers are fastened, which ensure even pressure of the door to the enclosure and do not introduce additional resistance to movement. The closing system has been designed in such a way as to ensure comfort of use and to meet technical requirements for enclosures with a high degree of IP protection.

Depth adjustment of installed equipment



Special construction of mounting brackets allows for step adjustment of the installation depth of the insert sets in a very wide range.

Possibility to divide the internal set horizontally and vertically



The EP-W dividing elements and BL WP dividing bars give complete freedom during configuration the internal sets.

Construction solutions that facilitate prefabrication



The use of consistent solutions and elements in the entire SOLID GSX system makes it much easier to assemble and manufacture. Uniform self-tapping screws and bolts allow for a less frequent tool change, and many small positioning details and markers shorten assembly time.

Removable internal sets



The SOLID GSX system enables simple assembly and disassembly of entire inserts with equipment and cabling in enclosures.

Plinths



PH plinths are screwed from four elements (front element, rear element and two side elements). In addition, each plinth is equipped with a bar for fixing wires and cables.

Both the front and rear element can be unscrewed, making wiring easier. In the side elements of the plinth, weaknesses were made to remove the plugs and lead the wires between the plinths in the enclosures combined together.

The plinths are symmetrical, this means that two or more plinths can be twisted together to achieve the target heights. The standard height of the plinth is 100 mm.

Membrane cable gland



The use of modern gland plates allows the introduction of wires without single cable glands and without the use of special tools. The full range of diaphragm cable glands for different cable cross-sections can be found on page 95.

Steel cable gland

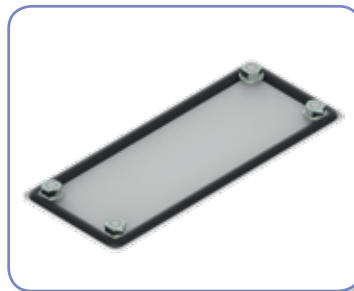

It allows to use cables and wires with larger crosssections (appropriate cable glands)

Double metal cable gland

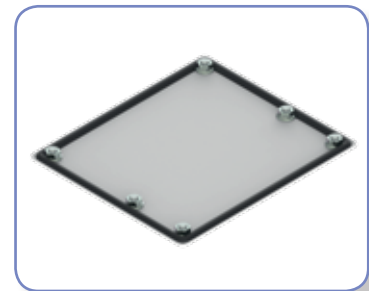

Double gland plates allow for faster assembly and to lead wires with larger diameters. When screwed into standard locations they cover two adjacent openings for mounting gland plates.



The holes for the gland plates (FL21 standard) are made in two rows. The number of holes depends on the width of the enclosure.

On pages 44 and 46 there are tables and dimensional drawings with arrangement of plinths. As standard, HXS enclosures are equipped with two rows of membrane gland plates screwed with M8 bolts from the top (EH-TKC-36-S).



HXS enclosures are equipped with double metal gland plates from the bottom. The poured gasket ensures a high degree of IP protection. The glands cover two adjacent openings in the FL21 standard. Each EH2 gland has M8 dowels fixed permanently and it is screwed with flange nuts from the center of the enclosure, which considerably facilitates their assembly and shortens the prefabrication time.

Accessories for HXS standing enclosure



U400
001102166



UCH-2
001101715



LK-WRS-D3
001343100



LK-WRS-D5
001343101

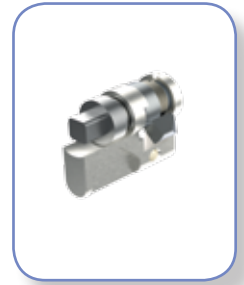

LK-WRS-KW8
001343103



LK-WRS-T9
001343104



LK-WRS-1333
001343102



KEY-D5-M
001102173



KEY-T9-M
001102174



KEY-KW8-M
001102175



KEY-UNI-M
(For locks D5, T9, KW8, N)
001102176



KEY-1333
001343000



LPE-6
001102177

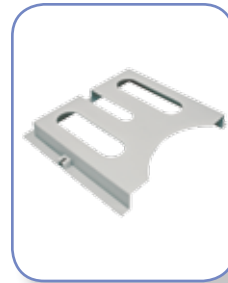

K-A4
001102178



K-A4-PT
001343200



FA-RAL7035
001101710

The rest accessories and equipment can be found in chapter "ACCESSORIES AND INTERNAL CONSTRUCTION SYSTEM" on page 48.

The possibility of any configuration of the internal set



Internal set holders
page. 86

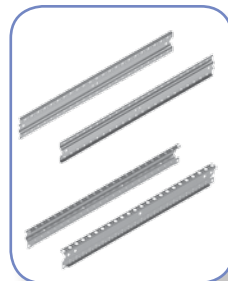

WP-A/WP-T vertical
brackets
page. 85

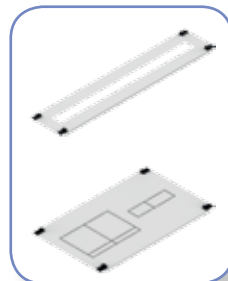

CP covers
page. 72

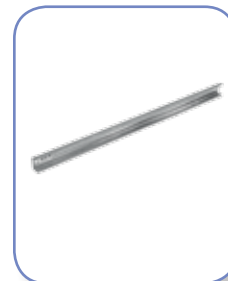

TH-S rails
page. 80

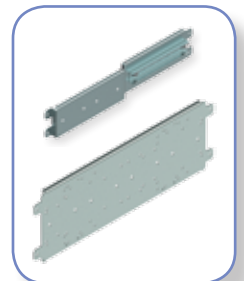

PM mounting plates
page. 80



BL-WP bars for dividing
horizontally
page. 87

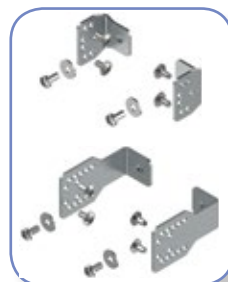

LG-V fixing elements
page. 91

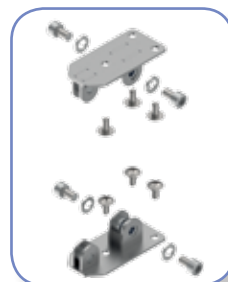

EP-W internal set
dividing elements
page. 87



UW-SEP support
dividing element
page. 87

The rest accessories and equipment can be found in chapter "ACCESSORIES AND INTERNAL CONSTRUCTION SYSTEM" on page 48.

Internal HXS enclosures equipment



Selected type of equipment that can be mounted according to the assembly instructions in HXS enclosures:

Type of equipment	Covers	Mounting plates and rails
Serial terminals	CP x-x F	TH-S x
Non-standard equipment	CP x-x FP	PM x-x PER-A lub PM-F x-24
Modular equipment	CP x-x M	TH-S x
HVL EK 00 disconnectors and modular equipment up to 160 A	CP x-x H00 M	PM x H00 M
KVL00 disconnectors and modular equipment up to 160 A	CP x-x K00 M	PM x K00 M
ED2 / EB2 125, 160, 250 A Switch disconnectors / Circuit breakers and modular equipment	CP x-x E12 M	PM x E12 M
LBS1 disconnectors up to 160 A and modular equipment	CP x-x S1 M	PM x E12 M
HVL EK 00 disconnectors up to 160 A	CP x-x H00	PM x H00
KVL00 disconnectors up to 160 A	CP x-x K00	PM x K00
KVL1 disconnectors up to 250 A	CP x-x K1	PM x ELS46 K123
KVL2 disconnectors up to 400 A	CP x-x K2	PM x ELS46 K123
KVL3 disconnectors up to 630 A	CP x-x K3	PM x ELS46 K123
ED2 / EB2 125, 160, 250 A Switch disconnectors / Circuit breakers	CP x-x E12	PM x E12 L12
ED2 / EB2 400, 630 A Switch disconnectors / Circuit breakers	CP x-x E46	PM x ELS46 K123
LBS1 disconnectors up to 160 A	CP x-x S1	PM x E12 L12
LBS2 disconnectors up to 250 A	CP x-x S2	PM x E12 L12
LBS3 disconnectors up to 630 A	CP x-x S3	PM x ELS46 K123
SL00/1/2/3 strip type fuse-switch-disconnectors	CP x-x SL	-



Serial terminals



Modular equipment



EB2 160 circuit breaker and modular equipment



HVL EK 00 disconnector



KVL00 disconnector



KVL1 disconnector



LBS 250 A disconnector



EB2 400 A circuit breaker

Dimensional drawings

Body of HXS300 enclosures

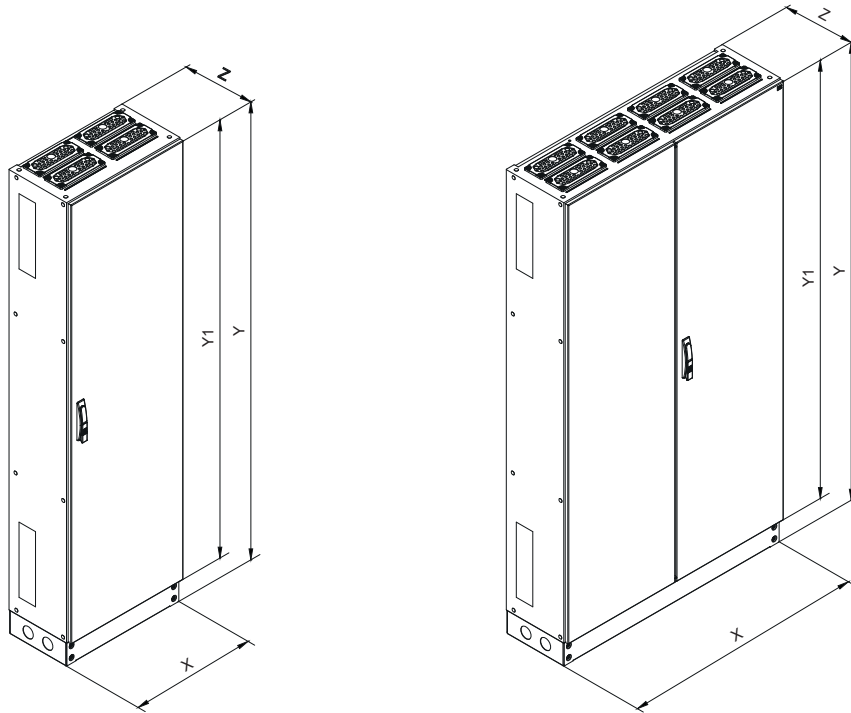

Type	X (mm)	Y (mm)	Y1 (mm)	Z (mm)	Number of doors
HXS300 2-12	550	1950	1850	300	1
HXS300 3-12	800	1950	1850	300	1
HXS300 4-12	1050	1950	1850	300	2

Holes for cable glands

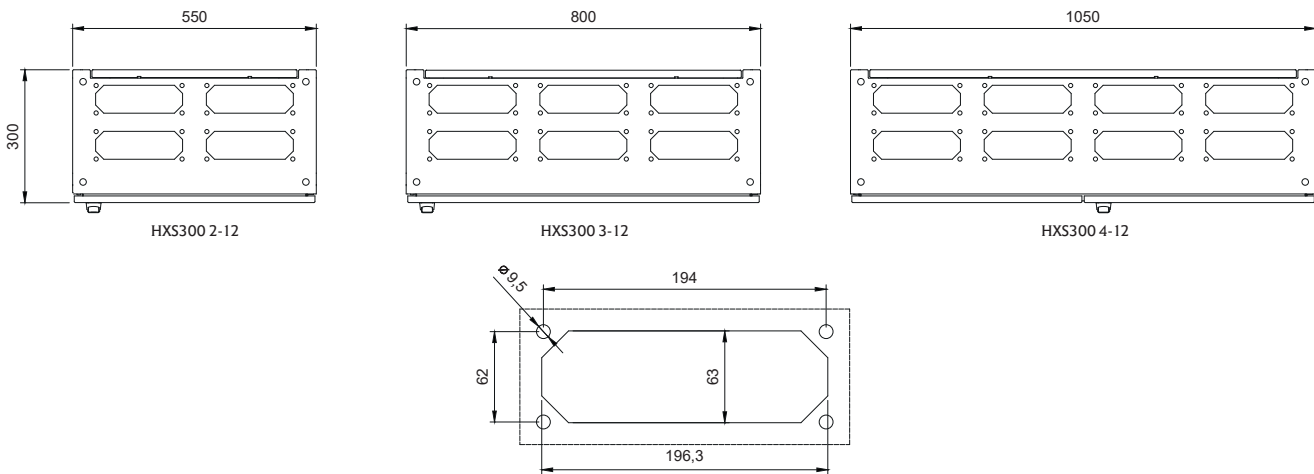

Type	Number of cable glands in enclosures	
	Top (diaphragm cable gland)	Bottom (double metal cable gland)
HXS300 2-12	4	2
HXS300 3-12	6	3
HXS300 4-12	8	4

Internal dimensions of HXS300 enclosure with UA-B, UW-BCU 23 and UW-BCR 3 handles

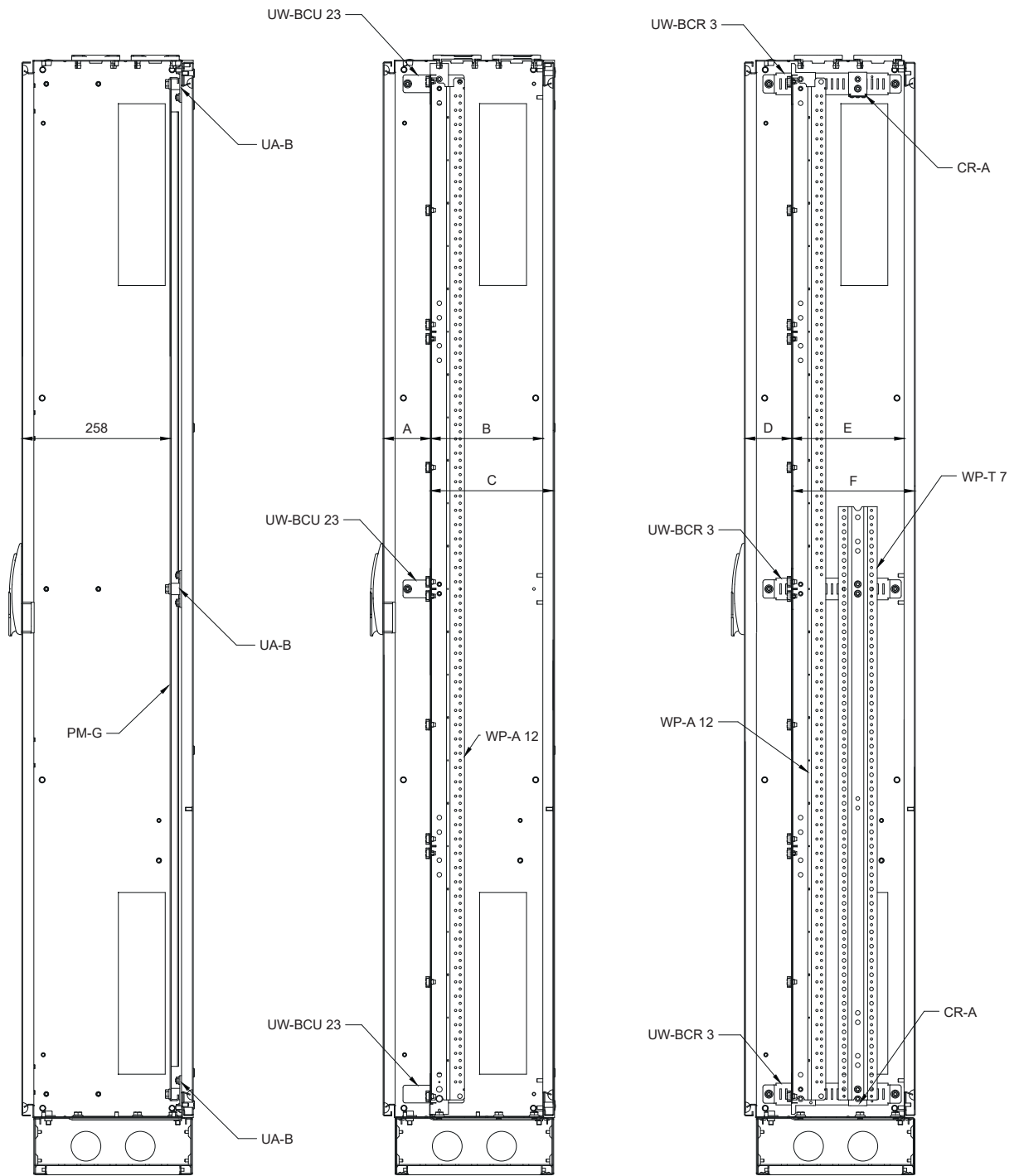

Enclosure with UA-B brackets for PM-G mounting plate

Enclosure with UW-BCU 23 handles for WP-A vertical supports

Enclosure with UW-BCR 3 handles for WP-A and WP-T vertical supports

Typical dimensions depending on the chosen mounting position of the internal set with equipment						
Mounting position	For UW-BCU 23 handles			For UW-BCR 3 handles		
	A (mm)	B (mm)	C (mm)	D (mm)	E (mm)	F (mm)
1	60	216	234	60	216	234
2	-	-	-	70	206	224
3*	80	196	214	80	196	214

The given dimensions do not take into account the distance to the lock mechanism

* basic position (see page 101)

Body of HXS400 enclosures

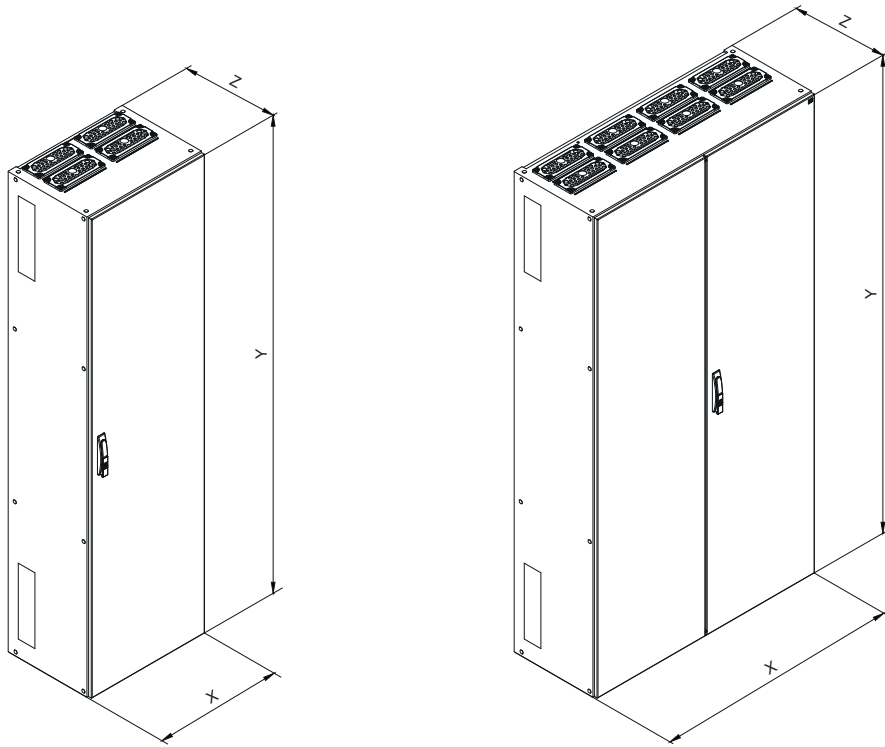

Type	X (mm)	Y (mm)	Z (mm)	Number of doors
HXS400 2-13	550	2000	400	1
HXS400 3-13	800	2000	400	1
HXS400 4-13	1050	2000	400	2

Holes for cable glands

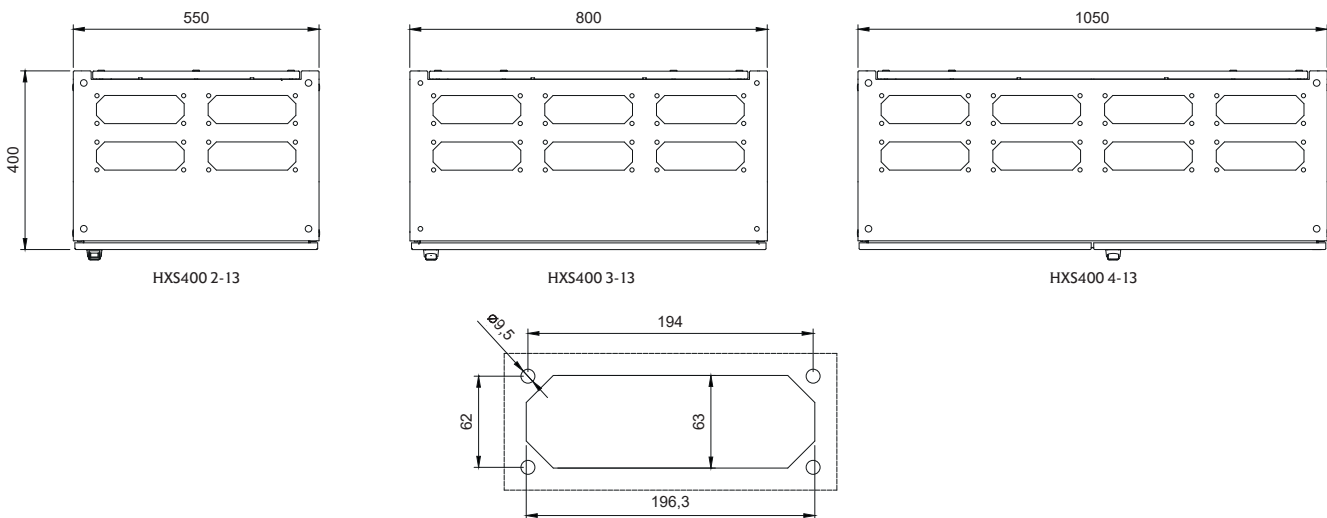

Type	Number of cable glands in enclosures	
	Top (diaphragm cable gland)	Bottom (double metal cable gland)
HXS400 2-13	4	2
HXS400 3-13	6	3
HXS400 4-13	8	4

Internal dimensions of HXS400 enclosure with UA-B, UW-BCU 4 and UW-BCR 4 handles

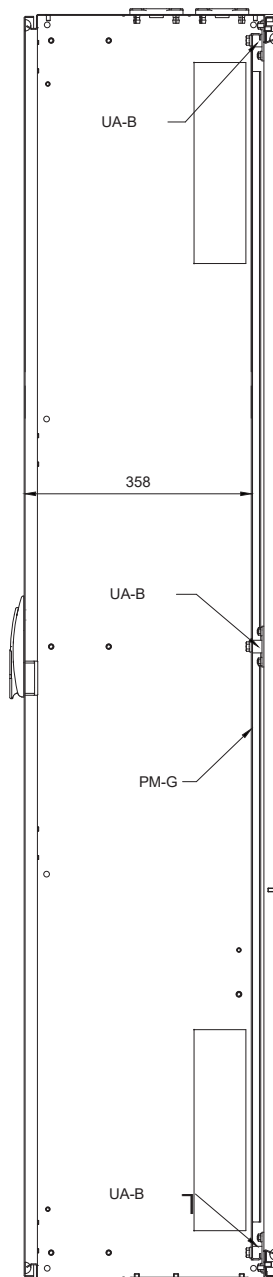

Enclosure with UA-B brackets for PM-G mounting plate

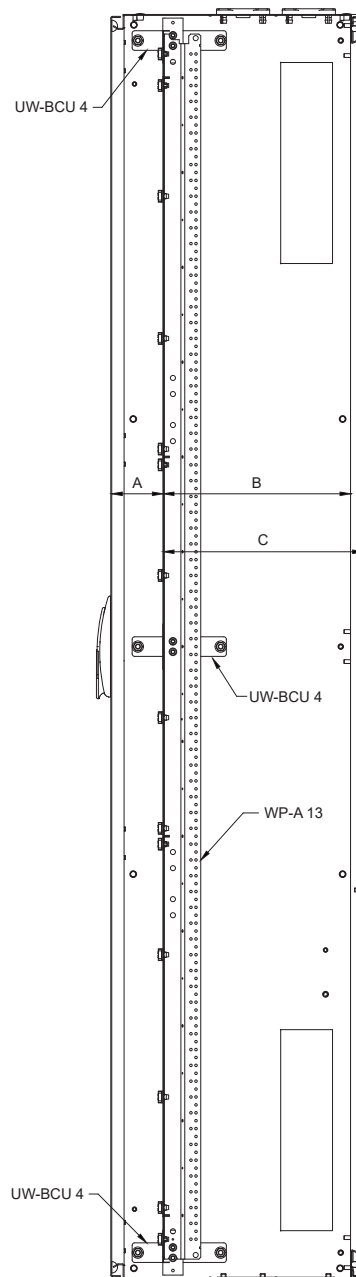

Enclosure with UW-BCU 4 handles for WP-A vertical supports

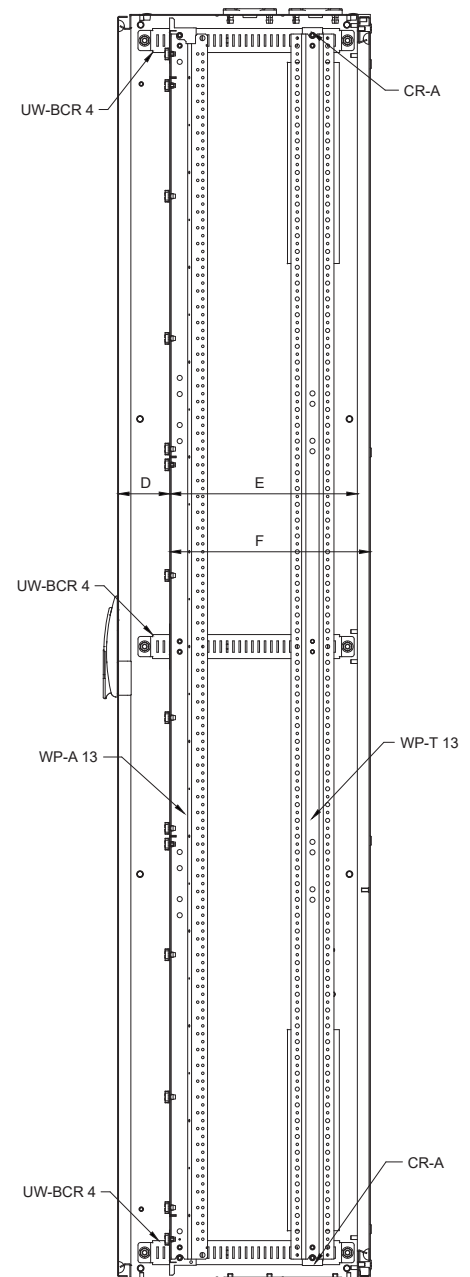

Enclosure with UW-BCR 4 handles for WP-A and WP-T vertical supports

Typical dimensions depending on the chosen mounting position of the internal set with equipment

Mounting position	For UW-BCU 4 handles			For UW-BCR 4 handles		
	A (mm)	B (mm)	C (mm)	D (mm)	E (mm)	F (mm)
1	-	-	-	60	316	334
2	-	-	-	70	306	324
3	80	296	314	80	296	314
4	-	-	-	90	286	304
5*	100	276	294	100	276	294
6	-	-	-	110	266	284
7	-	-	-	120	256	274
8	-	-	-	130	246	264
9	-	-	-	140	236	254
10	-	-	-	150	226	244

The given dimensions do not take into account the distance to the lock mechanism
 * basic position (see page 101)

Accessories and internal construction system

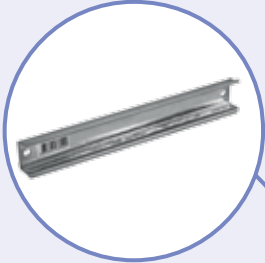

→ Ability to install mounting rails at an angle

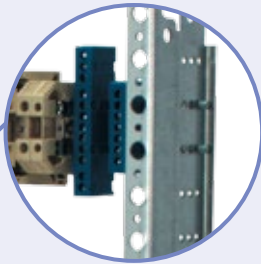

→ Vertical brackets: WP-A with adjustable depth of mounting plates and the possibility of dividing the enclosure vertically and WP-U without depth adjustment and without the possibility of dividing the enclosure (economic version)



→ Earthing terminals in CP covers for protection against electric shock



→ Universal self-tapping screw for fixing brackets, mounting plates, TH rails

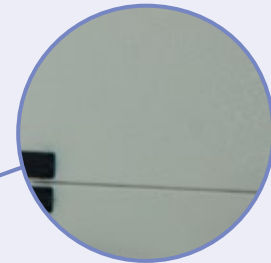

→ Covers painted with polyester paint resistant to UV radiation



→ CP covers and PM mounting plates dedicated to ETI equipment (disconnectors, circuit breakers) - perforation in plates and weakening to cut in covers

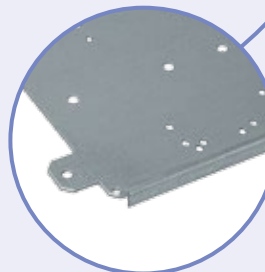

→ All mounting plates have a positioning hole in the bottom left corner



→ Vertical dividing thanks to the EP-W element and horizontally thanks to the BL-WP dividing bars. Very easy assembly of the internal set



→ Fast and easy assembly of covers by the use of special clips with the possibility of sealing

Accessories and internal construction system

The internal construction system and accessories allow to adapt the SOLID GSX enclosures to the requirements of various applications.

Dedicated CP covers and PM mounting plates enable the installation of various types of equipment without the need for additional drilling or cutting holes. A wide range of LG-V fixing elements allows to optimally adjust the mounting depth of the equipment. The EP-W dividing elements together with the BL-WP dividing bars make it possible to divide the internal set both vertically and horizontally. The main construction elements and accessories fit different types of enclosures from the SOLID GSX system.

In the internal construction system, it can be distinguished:

- full and modular CP covers
- dedicated CP covers
- TH-S mounting rails
- PM mounting plates
- PM-G mounting plates for standing enclosures
- WP-A, WP-U, WP-T and WD-K vertical supports
- LG-V, LG-V5, LG-V6 and LG-T6 fixing elements
- UW-GT, UW-BCU, UW-BCR, CR-A handles
- UW-SEP, EP-W, EP-A, BL-WP dividing elements
- LG-B60, UD-B60, LG-T-B 185 and LG-T-INH brackets with insulating supports for busbars
- EH-TKC, EH-TC, EH-ST, EH-AL cable glands
- locks, inserts and keys for enclosures
- wall brackets for enclosures
- pockets, gaskets, pliers
- bolts, nuts, washers.

Advantages:

- CP covers and PM mounting plates are dedicated to ETI devices (disconnectors, circuit breakers) – perforated plates and covers are prepared to quick cut-outs the holes
- Quick and easy covers installation the use of special sealable clips
- CP covers earthing pins ensure protection against electric shock
- Vertical dividing thanks to the EP-W element and horizontally thanks to the BL-WP dividing bars. Very easy assembly of the internal set
- Very easy assembly of the internal set
- Vertical brackets: WP-A with adjustable depth of mounting plates and the possibility of dividing the enclosure vertically and WP-U without depth adjustment and without the possibility of dividing the enclosure (economic version)
- Universal self-tapping screw for fixing brackets, mounting plates, TH rails
- Ability to install mounting rails at an angle
- Different Types of locks matching the entire system GSX
- Metal enclosures painted with polyester paint resistant to UV radiation

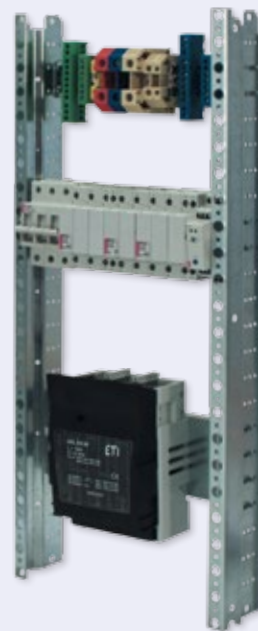
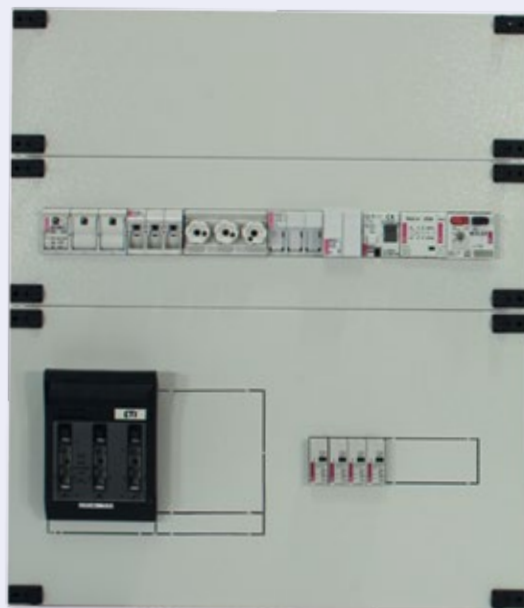

Advantages and technical characteristics

Ostony CP

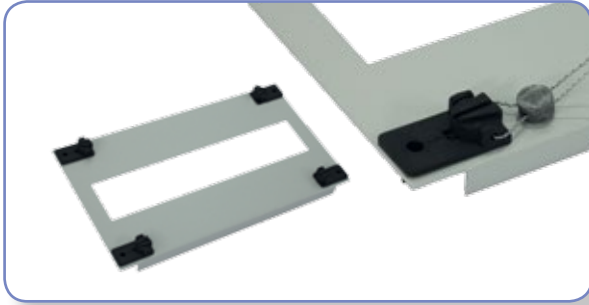

- CP covers are made of powder-coated sheet steel. All covers are equipped with earthing pins (if any equipment is mounted on the covers or insulating gaps are less than shown in EN 61439- 1 standard a cover grounding is recommended).
- CP covers are equipped with clips fastening in commercial set. Clips have the possibility of sealing. The special design of the clips allows easy and fast cover installation.

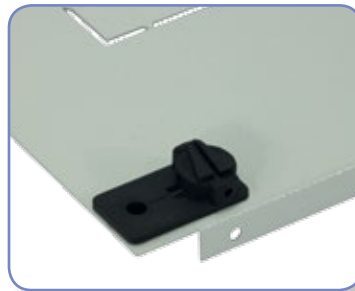
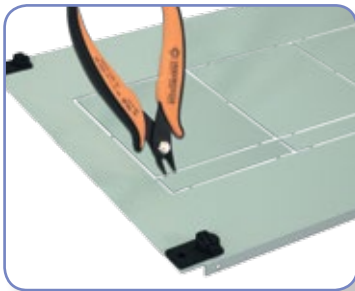

- The offer includes plain covers, covers matching to 45 mm modular equipment, covers dedicated for MCCB's EB/ED, disconnectors with fuses LTL/HVL/KVL, switch disconnectors type LA/LBS and combined with an additional 45mm holes for modular equipment.
- Special mounting plates are provided for dedicated covers. On pages 64 - 71 there are configuration tables to facilitate the selection of covers, plates and fixing elements for various types of equipment.
- Covers dedicated to EB / ED, LTL / HVL / KVL, LA / LBS types of equipment require installation in a specific positions. For ease of use, a positioning hole has been added, which should be found in the lower left corner.
- The covers have weaknesses for the cut-out to allow adjustment to various sizes of devices and configurations (different mounting depth, right-left). Weaknesses should be cut using CP-PLIER pliers adapted for this purpose.
- The method of fixing the electrical equipment, covers and mounting plates to brackets is included in the appropriate assembly instructions supplied with the CP shields (instructions are also available on the website www.etipolam.com.pl).

CP-B additional covers



- CP-B additional covers allow to complete the elevation of HXS enclosures between the enclosure body and the internal set.
- Vertical CP-BV additional covers should be selected depending on the height of the enclosure. They are sold in sets of 4 pieces.
- Horizontal additional covers are available in the divided versions: CP-BH and CP-BHS., Both versions are selected depending on the enclosure width. They are sold in sets (top + bottom set).
- Horizontal divided additional covers are dedicated to HXS enclosures with a divided internal set. They can also be used in enclosures without dividing the internal set by twisting the individual parts of the enclosures together (enclosure connectors included).

TH35 mounting rail

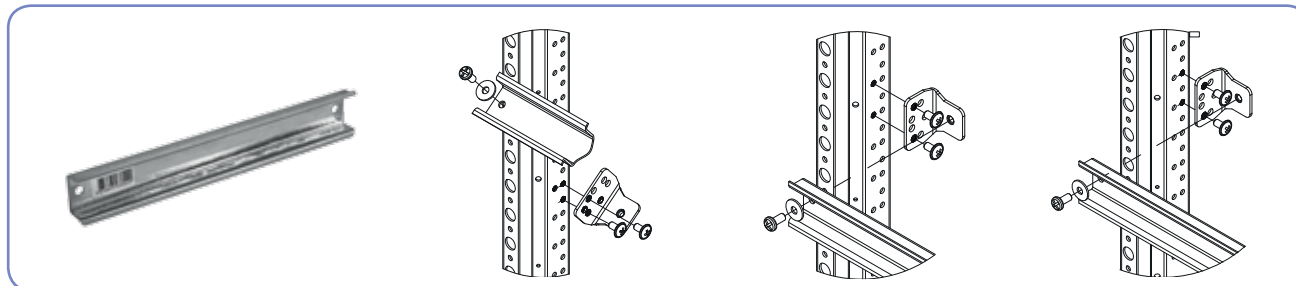

- The mounting of TH-S rails is possible at different distances from the cover (using the LG-V bracket: the minimum distance of the rail from the cover is 42.5 mm, the basic mounting distance is 48.5 mm, the maximum 64.5 mm; V5 minimum distance is 70 mm, basic mounting distance 76 mm, maximum 92 mm).
- It is also possible to mount the TH-S rail at an angle in vertical deflection. This facilitates the approach with wires to the terminals of connectors mounted on the rail.

PM mounting plates



- Mounting plates are made of galvanized steel sheet with a thickness of 1.5 to 3 mm. The plates have holes for mounting ETI electrical equipment. In mounting plates intended for disconnectors and circuit breakers EB / ED, LTL / HVL / KVL, LBS with modular equipment, a TH rail with a height of 15 mm is installed. As well as the covers, the mounting plates have a positioning hole, which after installation should be in the lower left corner.
- To improve stiffness, the plates have bent edges.
- To attach the electric equipment to the mounting plate, you must purchase appropriate screws, nuts and washers. EB circuit breakers and ED disconnectors up to 250 A have M4 screws included (2 pieces, 3-pole version, 4 pieces 4-pole) without nuts and mounting washers.
- Mounting plates for WP-A vertical supports are fastened with LG-V, LG-V5, LG V6-B, LG-V6-D or LG-V6R-B elements. The method of fixing the electrical equipment, covers and mounting plates to brackets is included in the appropriate assembly instructions supplied with the CP shields (instructions are also available on the website www.etipolam.com.pl).

PM-G mounting plates

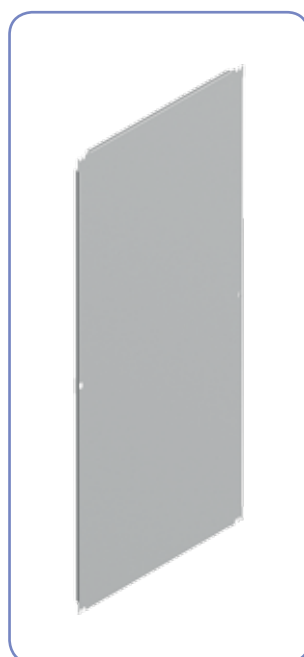

PM-G mounting plates are designed for HXS300 and HXS400 standing enclosures.

- They are available in four widths: 250 mm, 500 mm, 750 mm and 1000 mm and in two heights: 1800 mm and 1950 mm.
- The height of the mounting plates should be selected in accordance with the enclosure height. PM-G x-12 mounting plates are designed for enclosures with a height of 12 (1850) and PM-G x-13 mounting plates for enclosures with a height of 13 (2000).
- It is allowed to use several mounting plates in one enclosure, provided that their total width does not exceed the width of the enclosure. In this case, it is necessary to use a stiffening bar ensuring the possibility of screwing the plates in the center of the enclosure. Stiffening bars are available in the BL-UA version mounted on the back of the enclosure and BL-UR with the possibility of adjusting the mounting depth (page 89)
- The plate rim is double bent (forming the shape of the "U" letter) which significantly increases the strength and allows a wider range of applications.
- The mounting plates are mounted in six points on the "back" of the enclosure or on the brackets enabling the adjustment of the installation depth.
- All PM-G mounting plates have markers to be drilled with a $\varnothing 8$ drill to support it with the stiffening bar.



→ EP-A dividing elements



→ EP-W dividing elements

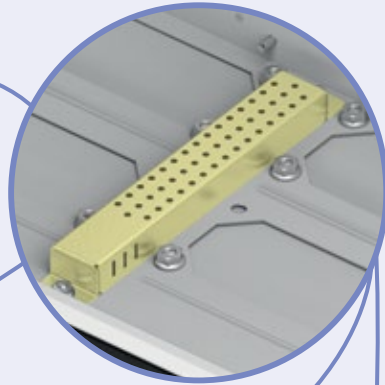

→ UW-SEP supports enable vertical dividing in HXS enclosures

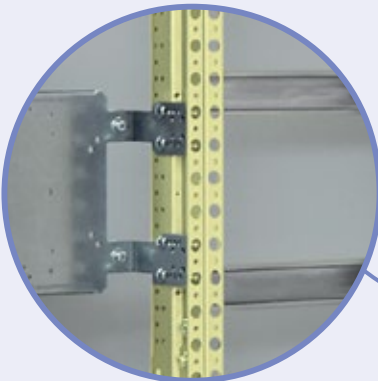

→ WP-A vertical supports are available in heights from 300 to 1950 mm



→ BL-WP division bars enable the separation of horizontal equipment sections. They guarantee orderly layout of devices and the lack of unused space in enclosures

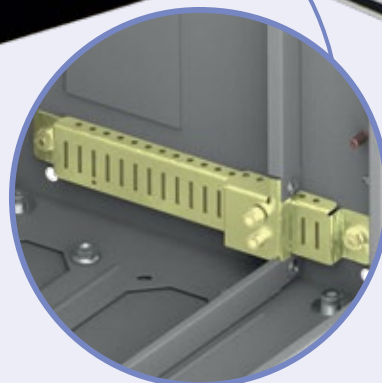

→ The UW-BCR handles allow for depth step adjustment of the internal set with electrical equipment

WP-U vertical supports

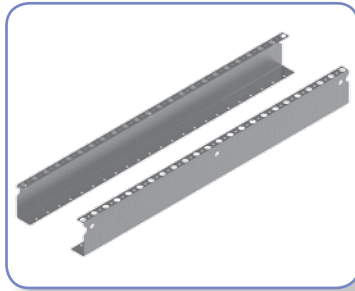

- Economical version of the vertical support without the possibility of dividing the enclosure and adjusting the mounting depth of TH-S rail and PM mounting plates. Fixed distance of TH-S rail to the covers, which is 48.5 mm.
- TH-S rails and PM mounting plates are mounted directly to the WP-U bracket using AST 4.8x9.5 self-tapping screws without the need to use LG V fixing elements.
- The brackets are fixed to the enclosure with M6x10 Allen screws supplied with a 4XN / 4XP enclosure.
- To mount the electrical equipment to the mounting plate, there is need to purchase the appropriate screws, nuts and washers. EB circuit breakers and ED disconnectors up to 250 A have M4 screws included (2 pieces, 3-pole version, 4 pieces 4-pole) without nuts and mounting washers.

WP-A vertical supports

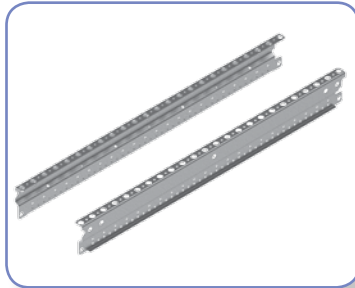

- The special design of the WP-A vertical support enables the assembly of the electrical equipment at various depths. Adjustment is possible thanks to the perforation of the bracket and LG-V elements in various variants. The TH-S assembly rails and PM mounting plates are attached to the LG-V element. The plates and rails are screwed to the LG-V elements with metric bolts.
- The design of the WP-A vertical support enables step mounting adjustment of TH-S rail, PM mounting plates and CP covers. The vertical adjustment is 25 mm, while the depth regulation of the TH-S rail and the PM mounting plates is 8 mm or alternately 6 mm and 2 mm (this is done thanks to the additional holes in the LG-V element).
- Opening the brackets gives the switchgear manufacturer the opportunity to choose the optimal distance between the equipment and covers.
- On the WP-A bracket, additional holes were provided to facilitate the determination of the mounting position of TH-S and PM plates. The spacing between openings is 150 mm and 75 mm.
- The bracket is fixed to the enclosure by means of allen screws M6x10 supplied with 4XN / 4XP enclosure or with internal set holders for GT or HXS enclosures.
- The brackets are packed in sets (left and right)

WP-T vertical supports

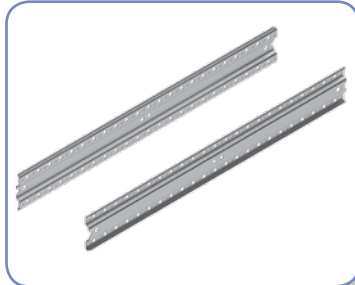

- The reinforced design of the WP-T vertical supports allows for the installation of heavy electrical equipment or busbar sets in HXS standing enclosures.
- The brackets can be mounted individually or as additional, rear brackets behind already installed WP-A brackets. This solution significantly facilitates the distribution of power in the switchgear and allows the busbar to be moved between each enclosures when several enclosures are combined into sets.
- WP-T brackets do not enable the assembly of CP covers.
- Available in three heights: 7 (1050 mm), 12 (1800 mm) and 13 (1950 mm).
- The brackets are packed in sets of 2 pieces.

WD-K rear support



- WD-K rear support made of 2 mm thick sheet metal with perforation adapted to cage nuts allows mounting of busbar insulators with 100 and 185 mm spacing in HXS standing enclosures.
- Available in two heights: 12 (1800 mm) and 13 (1950 mm).
- The height of the bracket should be selected in accordance with the height of the enclosure in which it is to be mounted.
- WD-K brackets can be mounted directly on the rear wall of the enclosure on UA-B-WD brackets or providing the possibility of adjusting the depth on the UR-B-WD brackets. To mount the WD-K brackets in the middle of the enclosure, use the UA-S bracket (mounting on the back wall) or UR-S (depth adjustment assembly).
- To stiffen the structure and support WD-K brackets in the middle of the enclosure, use a BL-UA stiffening bar (rear wall mounting) or BL UR (depth adjustment assembly) with brackets intended for WD-K brackets (BU-WD holder)
- WD-K brackets are symmetrical and sold in 1 piece without cage nuts, which must be ordered separately (cage nuts available on page 100)

UW-GT internal set holders

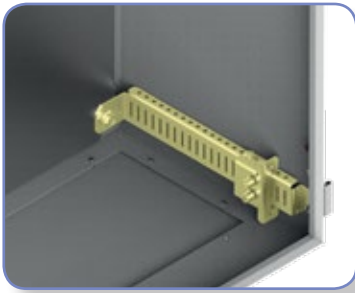

- The UW-GT internal set holder extends the capabilities of the universal GT hermetic enclosures and enables mounting in these enclosures a internal set with equipment on a WP-U or WP-A brackets.
- The set includes a set of holders for one GT enclosure.
- The UW-GT handle should be selected depending on the depth of the enclosure in which it will be mounted.
- UW-GT handles with depths of 300 mm and 400 mm provide the possibility of adjusting the depth of installation of the internal set with the equipment with a step of 10 mm.

UW-BCU internal set holders

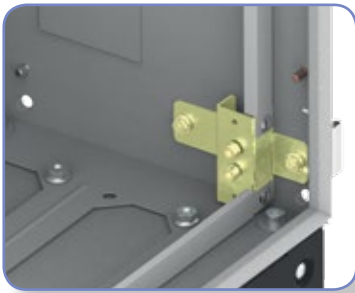

- The simple design of the UW-BCU handle allows you to easily mount the WP-A vertical supports in HXS standing enclosures. The handle can be rotated by 180° increasing the space between the door and the covers by an additional 20 mm.
- In each UW-BCU set there are two holders with nuts, bolts and washers necessary for mounting in the enclosure.
- For enclosure with a height of 12 (1800 mm) and 13 (1950 mm), 6 handles (3 sets of UW-BCU) should be used.

UW-BCR internal set holders



- UW-BCR handle is an alternative solution for mounting WP-A brackets in HXS standing enclosures. The construction of the handle provides a step adjustment of the installation depth by 10 mm. The holder consists of a support element screwed to the side of the enclosure and a leading element to which the vertical support, side, top and bottom additional covers are screwed.
- It is also possible to mount the rear WP-T brackets on additional CR-A elements.
- In each UW-BCR set there are two handles with leading elements and a set of self-tapping screws, screws and washers necessary for assembly in the enclosure.
- For enclosure with a height of 12 (1800 mm) and 13 (1950 mm), 6 handles (3 sets of UW-BCR) should be used.

CR-A leading element



- The CR-A leading element enables the installation of WP-T vertical supports, WD-K vertical supports or PM-G mounting plates on the UW-BCR internal set holder. Thanks to the special design of the handle and the connecting element, it is possible to adjust the installation depth by 10 mm.
- The CR-A element does not have the possibility of screwing the enclosures.
- The CR-A element is sold in sets of two pieces with a set of self-tapping screws, bolts and washers necessary for assembly.
- Depending on the height of the selected WP vertical support, 2 or 3 sets of CR-A should be used.

Vertical division of the internal set

- An important advantage of the SOLID GSX system is the possibility of dividing the enclosure vertically using the EP W, EP-A, UW-SEP elements and WP-A and WP-T vertical supports. As a result, a electrical equipment, a cable or a teletechnical section can be separated in one enclosure.
- In HXS standing enclosures it is also possible to mount an additional, rear internal set intended for example for distribution of power supply with busbars.
- It is not possible to divide the enclosure by using the WP-U vertical support (economical version without the possibility of adjusting the depth of TH-S rails, PM mounting plates and the possibility of dividing the enclosure into sections).

EP-W dividing element



- EP-W dividing element is designed for 4XN 160, 4XP160 and HXS standing enclosures (after using an additional UW-SEP support element). Thanks to a special design, it facilitates the assembly and disassembly of the internal set with the division on WP-A vertical supports (on the basis of a cradle).
- The EP-W dividing element is sold in sets of two pieces with a set of screws, washers and sheet metal screws.
- The EP-W SET includes: 2 divisional elements, 6 self-tapping screws, 4 M6x10 allen screws and 4 washers.

EP-A dividing element



- The EP-A mounting element, like the EP-W, allows the internal set to be divided. Its simplified design will not facilitate the insertion of the internal set on the basis of a cradle, however, thanks to this element the WP-T rear vertical supports can be mounted in standing enclosures.
- The EP-A dividing element is sold in sets of two pieces with a set of screws, washers and sheet metal screws.
- The EP-A SET contains: 2 divisional elements, 6 self-tapping screws, 2 M8 Allen screws and 2 washers.

UW-SEP dividing support

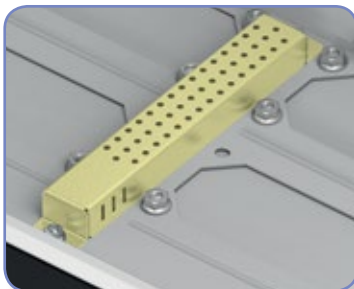

- The UW-SEP support provides functionality for the division of the internal set in HXS standing enclosures.
- After installing UW-SEP in the enclosure, you can use standard EP-W dividing sets, in addition, thanks to a special design, it allows you to adjust the depth of assembly of the entire internal set with equipment. UW-SEP dividing support is sold individually with two M6 nuts and one horizontal connector.

Horizontal division of the internal set

- Horizontal division of the internal set opens new possibilities in the design of the elevation and the arrangement of the equipment in the SOLID GSX enclosures. The smallest height of the section that can be realized is 300 mm, which results from the height of the lowest WP-A vertical support available in the offer. The horizontal division can be duplicated and combined with the vertical division creating unique structures adapted to the most demanding projects.
- The division of the insert significantly facilitates the distribution of cabling and power supply and ensures orderly arrangement of the equipment in the switchgear.

BL-WP dividing bar



- The BL-WP bar allows to divide the internal set depending on the width and configuration into two or three columns. The BL-WP 2 with a width of 500 mm can divide the internal set into two columns of 250 mm. However, the BL-WP 3 bar with a width of 750 mm allows to divide into three columns (each 250 mm) or two columns (one 250 mm wide and the other 500 mm wide).
- When dividing the internal set, attention should be paid to the maintenance of correct insulation distances between the electrical equipment and the construction components, especially the distance to the BL-WP dividing bar. The bar can be turned over by 180° and assembled depending on needs from the top or bottom of the WP-A vertical support.
- The BL-WP divider bar is sold in sets with a supporting element (500 mm wide beam - 1 supporting element, 750 mm wide beam - 2 supporting elements) and with a set of screws, washers and sheet metal screws necessary to mount it in the enclosure.
- With simultaneous vertical and horizontal division of the 3 mm (750 mm) internal set, remember that the bottom section is divided into 2 + 1, 1 + 2 or 1 + 1 + 1 and need to provide at least one middle support point.
- Using the BL-WP 3 dividing bar without providing at least one division in the bottom section is not allowed.

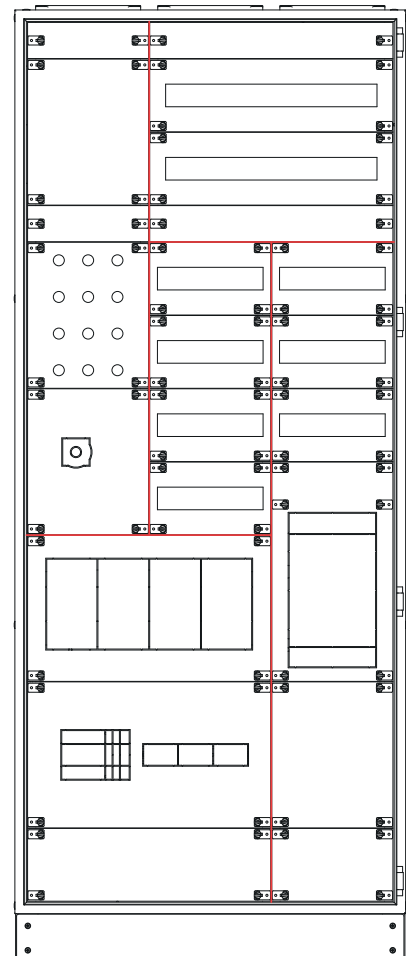
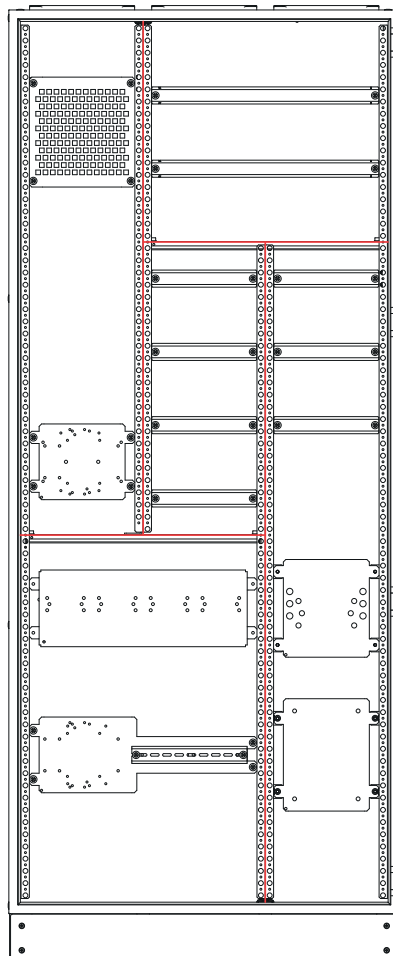
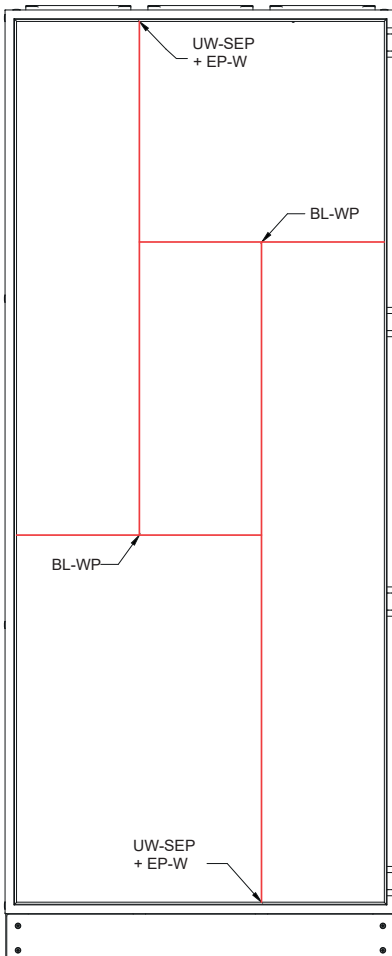

An example of the division of the internal set in the HXS enclosure

UA-B side handle



- The UA-B side bracket is used to attach the PM-G mounting plates or WD brackets directly to the rear wall of the enclosure. When using the UA-B bracket for WD vertical support, it should be remembered that the central fastening can cause a collision with the POP 100/185 insulation carrier, limiting the possibility of mounting the busbars at any height. In order to avoid collisions, a dedicated UA-B-WD bracket should be used.
- The UA-B bracket is mounted on the side edges of the enclosure (3 pcs on each side) on dedicated threaded pins.
- In order to mount a single PM-G mounting plate in the HXS enclosure on the back wall, where the width of the mounting plate is equal to the width of the enclosure mounting window (the simplest configuration), use 6 pieces of UA-B brackets (3 sets).
- UA-B side brackets are sold in sets of 2 pieces.

UA-B-WD side bracket for WD supports

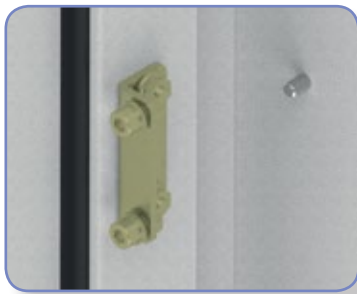

- The UA-B-WD side bracket is used to attach the WD supports directly to the back of the enclosure.
- The UA-B-WD bracket is mounted on the side edges of the enclosure (3 pcs on each side) on dedicated threaded pins.
- To install a single WD support, use 3 pieces of UA-B-WD brackets.
- UA-B-WD side brackets are sold in sets of 2 pieces.

Central UA-S bracket

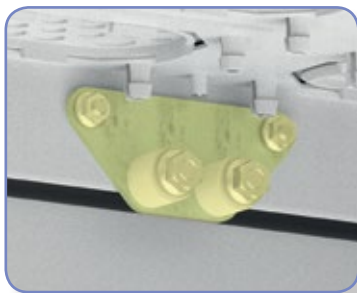

- The central bracket UA-S is used to attach WD brackets or PM-G mounting plates directly to the back of the enclosure (when the mounting plate width is smaller than the width of the enclosure mounting window).
- The UA-S bracket is mounted on the upper and lower edges of the enclosure on dedicated threaded pins.
- To install a single WD support, there is need to use 2 pcs of UA-S brackets. The number of brackets necessary to mount the PM-G mounting plates depends on the configuration, each bracket allows mounting of two adjacent mounting plates.
- UA-S middle brackets are sold in sets of 2 pieces.

Side UR-B bracket (mounting depth adjustment)



- The UR-B side bracket is used for mounting the PM-G mounting plates ensuring the adjustment of the installation depth.
- The UR-B bracket is mounted on the internal set holders with UW-BCR adjustment.
- If the mounting plate is to be mounted behind an already existing mounting internal set, additional CR-A leading elements should be used.
- In order to mount a single PM-G in the HXS enclosure with the regulation of the installation depth, where the width of the mounting plate is equal to the width of the enclosure mounting window (the simplest configuration), 6 UR-B holders should be used.
- UR-B side brackets are sold in sets of 2 pieces.

Side UR-B-WD bracket for WD supports (mounting depth adjustment)



- The UR-B-WD side bracket is used for attaching WD supports, providing depth control of the mounting, while limiting the possibility of collision with the POP 100/185 insulation carrier.
- The UR-B-WD bracket is mounted on the internal set holders with UW-BCR adjustment.
- If the WD bracket is to be mounted behind an already existing mounting internal set, additional CR-A leading elements must be used.
- In order to mount a single WD bracket in the HXS enclosure with adjustable depth of the mounting, use 3 pcs of UR-B-WD brackets.
- UR-B-WD side brackets are sold in sets of 2 pieces.

UR-S center bracket

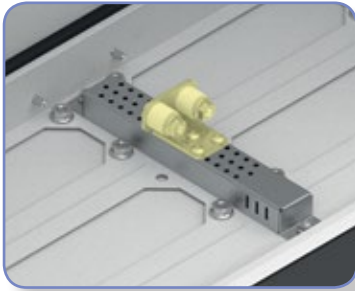

- The UR-S center bracket is used for attaching WD supports or PM-G mounting plates to ensure the installation depth adjustment (when the mounting plate width is smaller than the width of the enclosure mounting window).
- The UR-S bracket is mounted on the UW-SEP dividing bracket.
- In order to mount a single WD bracket, use 2 pcs of UR-S brackets. The number of brackets necessary to mount the PM-G mounting plates depends on the configuration, each bracket allows to mount two adjacent mounting plates.
- UR-S middle brackets are sold in sets of 2 pieces.

BL-UA and BL-UR stiffening bars

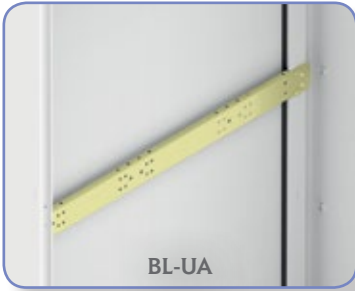

- Stiffening bars provide an additional support point for WD supports and PM-G mounting plates.
- Stiffening bars are available in the version to be mounted directly on the back wall of the enclosure (BL-UA) and in the version enabling the regulation of the depth of the installation (BL-UR).
- Depending on the application, the brackets for the PM-G mounting plate (BU-PM) or for the vertical support WD (BU-WD) should be purchased
- Stiffening bars are sold for 1 pc.

BU-PM bracket



- BU-PM brackets are designed for mounting PM-G mounting plates on a stiffening bar.
- Each BU-PM bracket provides one fulcrum for the PM-G mounting plate.
- BU-PM brackets are sold in sets of 2 pieces with a set of bolts and nuts necessary for their assembly on the stiffening bar and distances and nuts for screwing the PM-G mounting plate.

BU-WD bracket

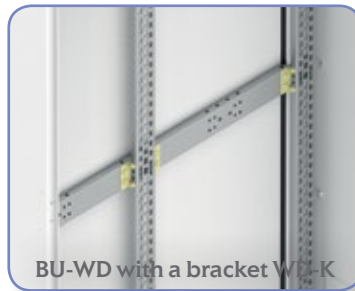

- BU-WD brackets are dedicated for mounting WD vertical supports on a stiffening bar.
- Each BU-WD bracket is one point of support.
- BU-WD brackets are sold in sets of 2 pieces with a set of screws, nuts and washers necessary for mounting brackets on the stiffening bar and attaching WD supports.

LG-V fixing elements



- The LG-V element is used for fixing TH-S rails and PM mounting plates to the WP-A vertical support. The fastening to the WP-A support takes place using two AST 4.8x9.5 self-tapping screws. The LG-V element has a metric M5 nut. TH-S rails and PM mounting plates are fastened to the LG-V element using M5 metric bolts (AS C 5x10) with AW-RE 5 washer.
- The LG-V element should be used for the assembly of TH-S rails intended for modular equipment, PM H00 M and PM K00 M mounting plates (for LTL00 / HVL00 / KVL00 switch disconnectors with modular equipment), PM ... E12 M (ED2 / EB2 125A, 160A, 250A disconnectors / circuit breakers with modular equipment), PM ... H00 and PM ... K00 (LTL00 / HVL00 / KVL00 switch disconnectors), PM..E12 L12 mounting plates (ED2 / EB2 125A, 160A, 250A disconnectors / circuit breakers).
- The assembly of TH-S rails is carried out using 2 LG-V (1 x LG-V SET set), PM mounting plates using 4 LG-V (2 x LG-V SET set).
- The LG-V element is packed: 50 pieces as a single element without self-tapping screws, metric bolts and washers or as a set (SET) consisting of 2 LG-V, 4 self-tapping screws, 2 washers and 2 M5 metric screws.

LG-V5 fixing elements

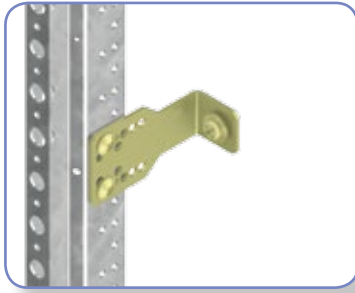

- The LG-V5 element is used for fixing TH-S rails and PM mounting plates to the WP-A vertical support. The fastening to the WP-A support takes place using two AST 4.8x9.5 self-tapping screws. The LG-V5 element has a metric M5 nut. TH-S rails and PM mounting plates are fixed to the LG-V5 element using M5 AS-C 5x10 metric screws with AW-RE 5 washer.
- The LG-V5 element allows you to place rails and mounting plates at a deeper depth than LG-V. The LG-V5 element should be used for mounting TH-S rails with terminal, PM ... E12 L12 mounting plates for LA1 (position 1) disconnectors, LA2 (positions 1 and 4) and for LBS 160 and 250 A disconnectors. Items shown in the instructions.
- TH-S rail mounting is done with 2 LG V5 (1 x LG-V5 SET set), PM mounting plates are mounting with 4 LG-V5 (2 x LG-V5 SET set).
- The LG-V5 element is packed: 20 pieces as a single element without self-tapping screws, metric bolts and washers or as a set (SET) consisting of 2 pieces LG-V5, 4 self-tapping screws, 2 washers and 2 M5 metric screws.

LG-V6-B fixing elements

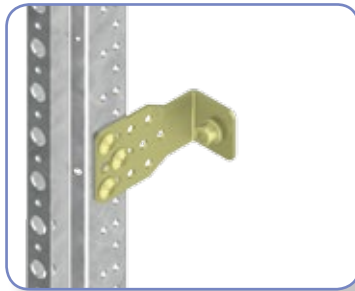

- The LG-V6-B element is used for fixing PM mounting plates with a higher load. The fixing to the WP-A support is done using two / three AST 4.8x9.5 self-tapping screws. In the element LG-V6-B there is a metric nut M6. PM mounting plates are fixed to the LG-V6-B element using M6x10 Allen screws (with washer). The LG-V6-B element allows assembly of devices with a larger mass than the LG-V5 bracket.
- The LG-V6-B element should be used for mounting PM mounting plates (before mounting, drill the mounting hole in PM plates with a Ø6 drill).
- LG-V6-B elements are sold only in sets of two pieces (SET) together with self-tapping screws, washers and screws necessary for assembly.

LG-V6-D fixing elements

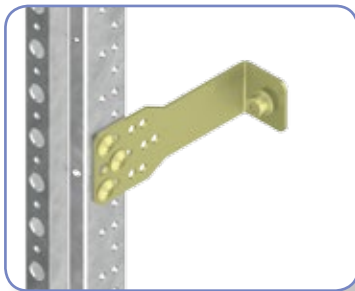

- The LG-V6-D element is a deeper equivalent of the B version, it is used for mounting PM mounting plates with a higher load. Similarly to other elements of LG-V, the fixing to the WP-A support takes place by means of two / three AST 4.8x9.5 self-tapping screws. The LG-V6-D element has an M6 metric nut. PM mounting plates are fixing to the LG-V6-D element using M6x10 Allen screws (with washer).
- The LG-V6-D element allows installation of devices with a larger mass than on the LG-V5 bracket and at a greater depth than LG-V6-B.
- The LG-V6-D element should be used for mounting PM mounting plates (before mounting, drill the mounting hole in PM plates with a Ø6 drill).
- Elements of LG-V6-D are sold only in sets of two pieces (SET) together with self-tapping screws, washers and screws necessary for assembly.

LG-V6R-B fixing elements

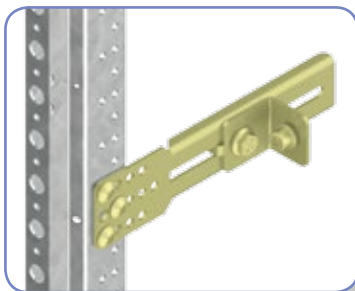

- The LG-V6R-B fixing element enables smooth adjustment of the mounting depth of TH-S rails or PM mounting plates. The fixing to the WP-A support is done using two / three AST 4.8x9.5 self-tapping screws.
- The LG-V6R-B element has an M6 metric nut.
- PM mounting plates are fixing to the LG-V element using M6x10 Allen screws (with washer).
- LG-V6R-B elements are sold only in sets of two pieces (SET) together with sheet metal screws, washers and screws necessary for assembly.

LG-T6-A fixing elements

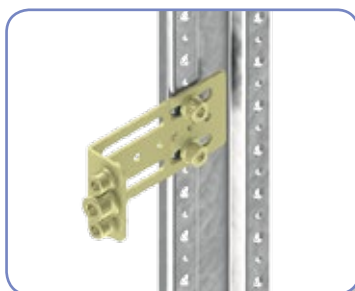

- The LG-T6-A fixing element, unlike the other elements from the LG-V group, is dedicated for mounting on WP-T back support.
- Thanks to the use of 2 mm thick metal sheet, this element can be used to mount equipment such as compact circuit breakers with motor drives.
- In the LG-T6-A element there are two metric nuts M6 and one M8 nut.
- PM mounting plates are fixed to the LG-T element using M6 allen screws or M8 (with washer).
- LG-T6-B elements are sold only in sets of two pieces (SET) together with washers and screws necessary for assembly.

LG-B60-H P1 support

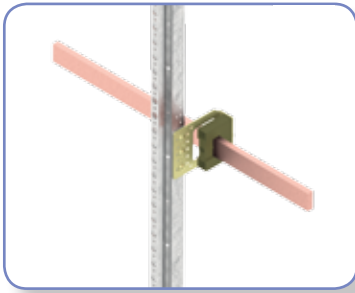

- Support with BBS insulating carrier for 1 busbar (width 30, 20, 25, 15, 12 mm and thickness 10, 6, 5 mm) mounted horizontally on WP-A / WP T supports.
- The construction of the support allows a step adjustment of the rail mounting depth.
- LG-B60-H P1 set is sold in sets, which includes: 1x metal support, 1x BBS insulating carrier for a single busbar and a set of screws and self-tapping screws necessary for mounting on the WP-A support.

LG-B60-H P3 support

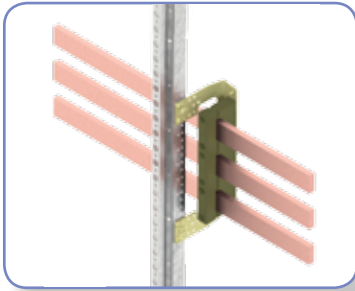

- Support with BBS insulating carrier for up to three busbars (30x10, 30x5, 20x10 or 20x5 mm) with 60 mm spacing, mounted horizontally on WP-A / WP T supports.
- The construction of the support allows for step adjustment of the rail mounting depth.
- Mounting depth of the support is suitable for installation on the busbar system such an equipment as KVL fuse switches in sizes NH00, 1, 2, 3.
- LG-B60-H P3 is sold in sets, which includes: 1x metal bracket, 1x BBS insulating carrier for 3 busbars and a set of screws and self-tapping screws necessary for mounting on the WP-A support.
- At the ends of the busbars, additional L-BBS-60/3 insulating covers should be used.
- If LG-B60-H P3 supports are installed in a position in which busbars or fixing elements are under a distance of less than 15 mm from WP-A / WP-T vertical supports or other metal parts of the construction of the internal set, additional L-WP-B60 / 3. insulating covers should be used.

LG-B60-H P4 support

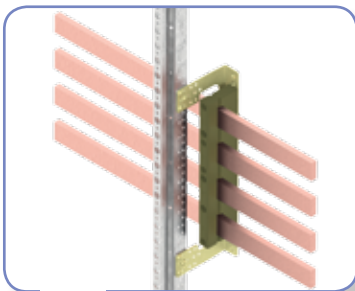

- Support with BBS insulating carrier for up to 4 busbars (30x10, 30x5, 20x10 or 20x5 mm) with a distance of 60 mm, mounted horizontally on WP-A / WP T supports.
- The construction of the support allows for step adjustment of the rail mounting depth.
- LG-B60-H P4 is sold in sets, which includes: 1x metal support, 1x BBS insulating carrier for 4 busbars and a set of screws and self-tapping screws necessary for mounting on the WP-A support.
- At the ends of the busbars, additional L-BBS-60/4 insulating covers should be used.
- If the LG-B60-H P4 supports are installed in a position in which busbars or fixing elements are under a distance of less than 15 mm from the WP-A / WP-T vertical supports or other metal parts of the internal set construction, additional insulating L-WP-B60 / 4 covers should be used .

LG-B60-V2 P3 support

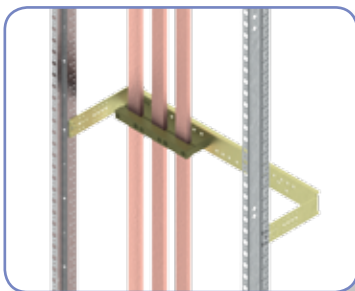

- Support with BBS insulating carrier for 3 busbars (30x10, 30x5, 20x10 or 20x5 mm) with 60 mm spacing mounted vertically, intended for mounting on WP-A / WP-T vertical supports .
- The construction of the support allows for step adjustment of the installation depth.
- The support is available for pole widths of 1 (250 mm) and 2 (500 mm).
- LG-B60-V2 P3 is sold in sets, which includes: 1x metal support, 1x BBS insulating carrier for 3 busbars and a set of screws, self-tapping screws and nuts necessary for mounting on WP-A supports.
- On a support with a width of 2 (500 mm) it is possible to mount an additional insulating carrier for 3 busbars.

LG-B60-V2 P4 support

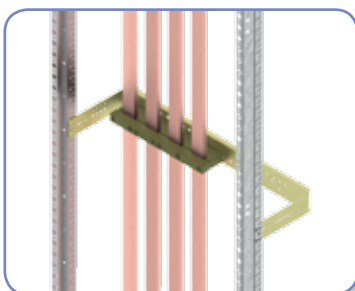

- Support with BBS insulating carrier for 4 busbars (30x10, 30x5, 20x10 or 20x5 mm) with 60 mm spacing mounted vertically, intended for mounting on WP-A / WP-T vertical supports.
- The construction of the support allows for step adjustment of the installation depth.
- The support is available for pole widths of 1 (250 mm) and 2 (500 mm).
- LG-B60-V2 P4 is sold in sets, which includes: 1x metal support, 1x BBS insulating carrier for 4 busbars and a set of screws, self-tapping screws and nuts necessary for mounting on WP-A supports.
- On a support with a width of 1 (250 mm) and 2 (500 mm) it is possible to install only one insulating carrier BBS-60/4 for 4 busbars.

Note: Support sets with insulation carriers LG-B60, UD-B60, LG-T-B185 and LG-T-INH are sold without busbars.

LG-B60-V2R P3 support

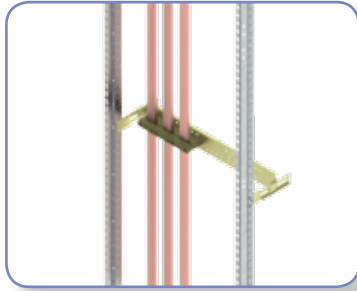

- Support with BBS insulating carrier for up to 3 busbars (30x10, 30x5, 20x10 or 20x5 mm) with 60 mm spacing mounted vertically with smooth adjustment of the mounting depth on WP-A / WP-T supports.
- The support is available for pole widths of 1 (250 mm) and 2 (500 mm).
- LG-B60-V2R P3 is sold in sets, which includes: 1 x metal support with handles for smooth regulation, 1 x BBS insulating carrier for 3 rails and a set of screws, self-tapping screws and nuts necessary for mounting on WP-A supports.
- On a support with a width of 2 (500 mm) it is possible to mount an additional insulating carrier for 3 busbars.

LG-B60-V2R P4 support

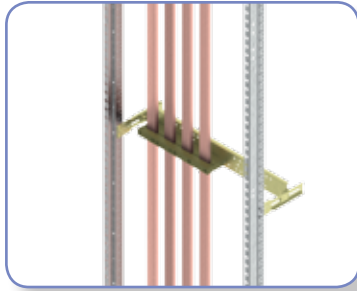

- Support with BBS insulating carrier for 4 busbars (30x10, 30x5, 20x10 or 20x5 mm) with 60 mm spacing mounted vertically with smooth adjustment of the mounting depth on WP-A / WP-T supports.
- The support is available for pole widths of 1 (250 mm) and 2 (500 mm).
- LG-B60-V2R P4 is sold in sets, which includes: 1 x metal support with handles for smooth regulation, 1 x BBS insulating carrier for 4 rails and a set of screws, self-tapping screws and nuts necessary for mounting on WP-A supports.
- On a support with a width of 1 (250 mm) and 2 (500 mm) it is possible to install only one insulating carrier BBS-60/4 for 4 busbars.

UD-B60-H P1 support



- Support with BBS insulating carrier for 1 busbar (width 30, 20, 25, 15, 12 mm and thickness 10, 6, 5 mm) designed for mounting directly to the body, on the back of the HXS enclosure.
- The support provides the possibility of carrying busbars between HXS enclosures (after breaking dedicated plugs in the enclosure body).
- The UD-B60-H P1 is sold in sets, consisting of: 1 x metal support, 1 x BBS insulating carrier for 1 busbar and a set of screws and nuts necessary for mounting directly to the body, on the back of the enclosure.
- The special construction allows the installation of two additional BBS-60/1 insulation carriers or one additional BBS 60/3 or BBS-60/4 carrier on the same support.

UD-B60-H P3 support



- Support with BBS insulating carrier for 3 busbars (30x10, 30x5, 20x10 or 20x5 mm) designed for mounting directly to the body, on the back of the HXS enclosure.
- The support provides the possibility of carrying busbars between HXS enclosures (after breaking dedicated plugs in the enclosure body)
- The UD-B60-H P3 is sold in sets, consisting of: 1 x metal support, 1 x BBS insulating carrier for 3 busbars and a set of screws and nuts necessary for mounting directly to the body, on the back of the enclosure.
- The special construction allows the installation of an additional BBS-60/1 insulation carrier on the same support.

UD-B60-H P4 support



- Support with BBS insulating carrier for 4 busbars (30x10, 30x5, 20x10 or 20x5 mm) designed for mounting directly to the body, on the back of the HXS enclosure.
- The support provides the possibility of carrying busbars between HXS enclosures (after breaking dedicated plugs in the enclosure body)
- The UD-B60-H P4 is sold in sets, including: 1 x metal support, 1 x BBS insulating carrier for 4 busbars and a set of screws and nuts necessary for mounting directly to the body, on the back of the enclosure.
- The special construction allows the installation of an additional BBS-60/1 insulation carrier on the same support.

Note: Support sets with insulation carriers LG-B60, UD-B60, LG-T-B185 and LG-T-INH are sold without busbars.

Short-circuit withstand capability for selected distances between carriers (60 mm rail spacing)				
	The distance between the carriers (mm)	Impulse current withstand I _{pk} (kA)	Rated short-time withstand current I _{cw} (kA)	Dimension of busbars L1-L3 (mm)
3-pole				
a	200	75,6	36,8	30x5
	600	47,5	22,8	
b	200	54,6	26,3	20x5
	600	30,5	15,5	
c	200	75,6	37,9	30x10
	600	45,7	22,3	
d	200	61,0	29,0	20x10
	600	34,0	17,1	

Short-circuit withstand capability depending on the distance between the carriers (60 mm rail spacing)

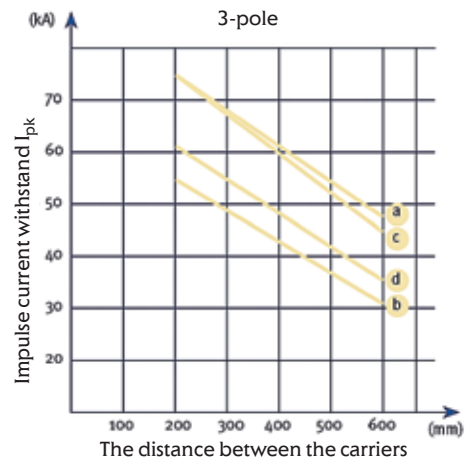

LG-T-B185-H P3 support

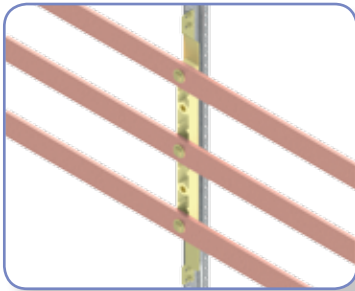

- Supports with POP 100/185 insulation carrier mounted horizontally on the WP-T support for 3 busbars (30x10, 40x10, 60x10, 80x10, 100x10 mm) with a distance of 100 or 185 mm.
- The special design of the LG-T-B185-H P3 support allows for step adjustment of the installation depth of the entire busbar system.
- The LG-T-B185-H P3 is sold in sets, consisting of: 1x metal support, 1x POP 100/185 insulating carrier and a set of screws, nuts and washers necessary for mounting on the WP-T support and screwing of the busbars (3 x M10 screw with washer).
- When LG-T-B185-H P3 supports are installed in a position where busbars or fixing elements are under a distance of less than 15 mm from WP A / WP-T vertical supports or other metal parts of the construction of the internal set, additional ZP POP-WP insulating covers need to be used.

Short-circuit withstand depending on the distance between the carriers (rail gauge 100 mm)

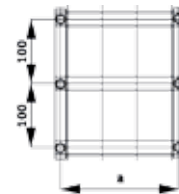
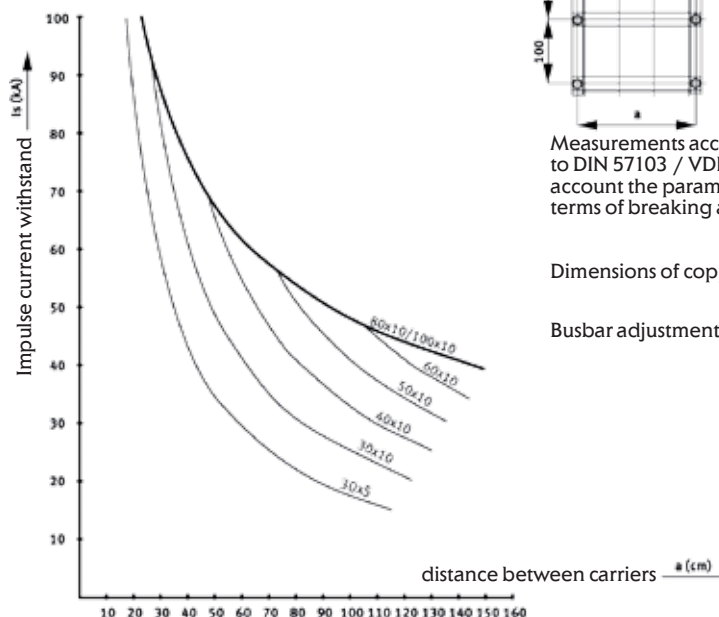

Measurements according to DIN 57103 / VDE 0103 taking into account the parameters of copper bars in terms of breaking and bending.

Dimensions of copper bars in mm.

Busbar adjustment

Note: Support sets with insulation carriers LG-B60, UD-B60, LG-T-B185 and LG-T-INH are sold without busbars.

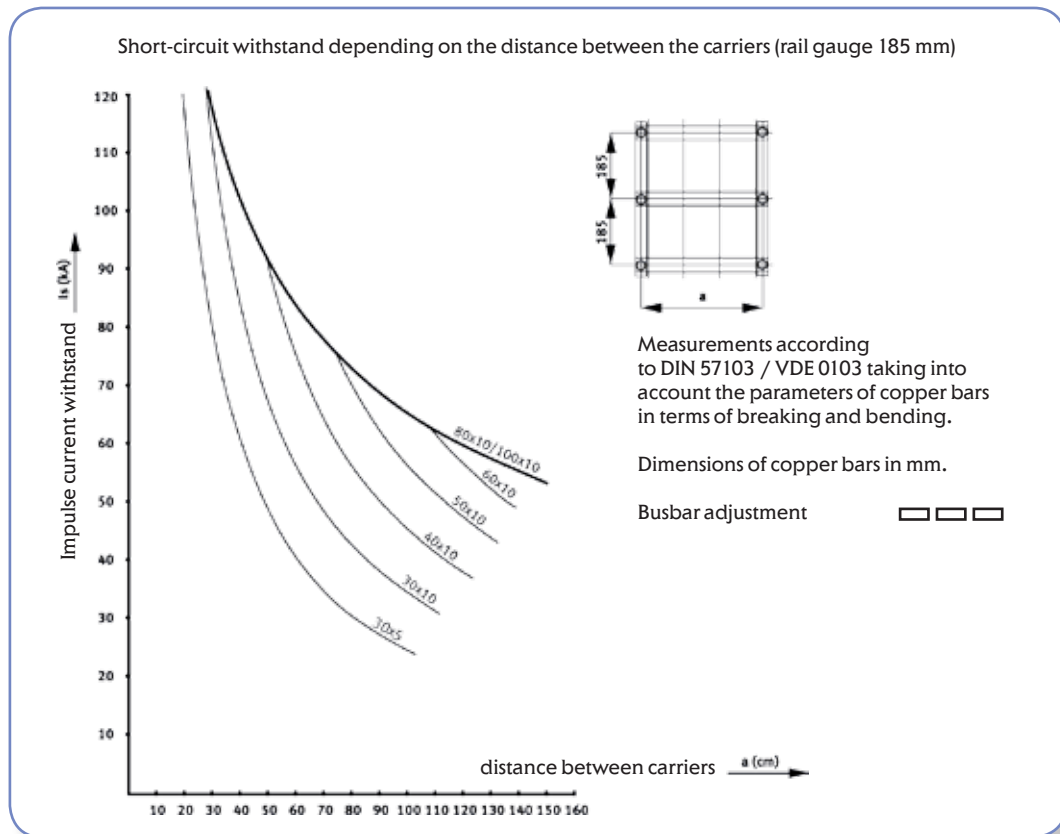

LG-T-INH1-A support with insulator

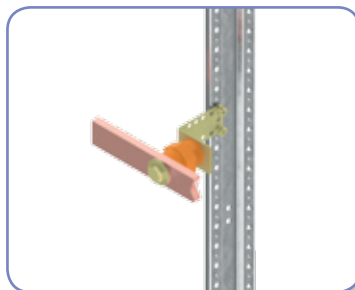





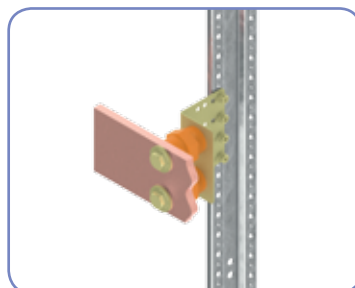















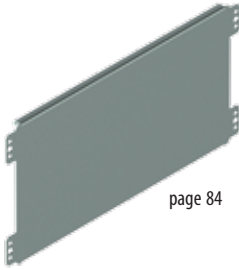

- The support with the INS insulator allows the installation of busbars (30x10 mm) on vertical WP-T supports .
- LG-T-INH1-A support with insulator is sold in sets, consisting of: 1x metal support, 1x INS insulator and a set of screws, nuts and washers necessary for mounting on the WP-T support and fixing the busbar.
- When LG-T-INH1-A supports are installed in a position where busbars or fixing elements are under a distance of less than 15 mm from WP A / WP-T vertical supports or other metal parts of the construction of the internal set, additional ZP POP-WP insulating covers should be used.

LG-T-INH2-A support with insulator

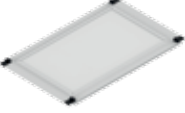

- The support with the INS insulator allows the installation of busbars (80x10, 100x10 mm) on WP-T vertical supports .
- LG-T-INH2-A support with insulators is sold in sets, which include: 1x metal support, 2x INS insulator and a set of screws, nuts and washers necessary for mounting on the WP-T support and fixing the busbars.
- When LG-T-INH2-A support are installed in a position where busbars or fixing elements are under a distance of less than 15 mm from WP A / WP-T vertical supports or other metal parts of the construction of the internal set, additional insulating ZP POP-WP covers should be used .

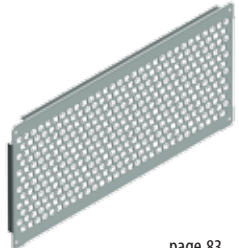
Note: Support sets with insulation carriers LG-B60, UD-B60, LG-T-B185 and LG-T-INH are sold without busbars.

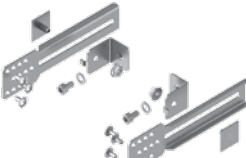











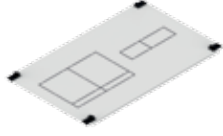
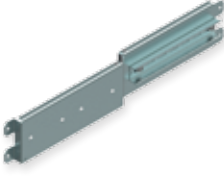

Selection table for covers, mounting plates, TH-S rails and fixing elements				
Type of equipment				
Type of equipment		Mounting plate	Fixing element	
Terminals type VS Large power contactors Busbars Safety and separation transformers Reserve space Completion the front of the enclosure	    	CP x-x F       page 72	TH-S x  page 80 PM-F x-24  page 84	LG-V SET  page 91 LG-V5 SET  page 91 LG-V6-B SET  page 91
Non-standard equipment	  	CP x-2 PF  CP x-3 PF  page 73	PM x-x PER-A  page 83	LG-V6-D SET  page 91 LG-V6R-B  page 91

Selection table for covers, mounting plates, TH-S rails and fixing elements

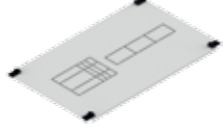
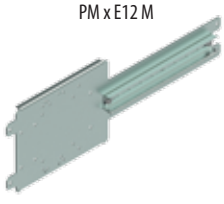

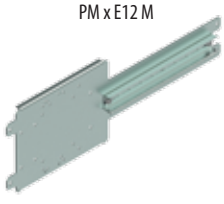





















































1 (250 mm)	1.4 (350 mm)	2 (500 mm)	2.2 (550 mm)	3 (750 mm)	3.8 (950 mm)	Fixing element
 CP 1-0.33 F 001101420	 CP 1.4-0.33 F 001101421		 CP 2.2-0.33 F 001101422	 CP 3-0.33 F 001101423	 CP 3.8-0.33 F 001101424	0.33 (50 mm)
 CP 1-0.5 F 001101425		 CP 2-0.5 F 001101426		 CP 3-0.5 F 001101427		0.5 (75 mm)
 CP 1-1 F 001101429	 CP 1.4-1 F 001101430	 CP 2-1 F 001101431	 CP 2.2-1 F 001101432	 CP 3-1 F 001101433	 CP 3.8-1 F 001101434	1 (150 mm)
 CP 1-2 F 001101436	 CP 1.4-2 F 001101437	 CP 2-2 F 001101438	 CP 2.2-2 F 001101439	 CP 3-2 F 001101440	 CP 3.8-2 F 001101441	2 (300 mm)
 CP 1-3 F 001101443		 CP 2-3 F 001101444		 CP 3-3 F 001101445		3 (450 mm)
 CP 1-4 F 001101447		 CP 2-4 F 001101448		 CP 3-4 F 001101449		4 (600 mm)
 CP 1-2 PF 001340050	 CP 1.4-2 PF 001340051	 CP 2-2 PF 001340052	 CP 2.2-2 PF 001340053	 CP 3-2 PF 001340054		2 (300 mm)
 CP 1-3 PF 001340056	 CP 1.4-3 PF 001340057	 CP 2-3 PF 001340058	 CP 2.2-3 PF 001340059	 CP 3-3 PF 001340060		3 (450 mm)
 TH-S 1 002911040	 TH-S 1.4 002911041	 TH-S 2 002911042	 TH-S 2.2 002911043	 TH-S 3 002911044	 TH-S 3.8 002911045	
 PM-F 1-24 001341000	 PM-F 1.4-24 001341001	 PM-F 2-24 001341002	 PM-F 2.2-24 001341003	 PM-F 3-24 001341004		
 PM 1-2 PER-A 001101621		 PM 2-2 PER-A 001101625		 PM 3-2 PER-A 001101629		

* full range of perforated PM x-x PER-A mounting plates on page 83









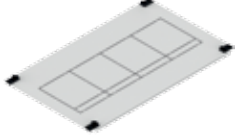
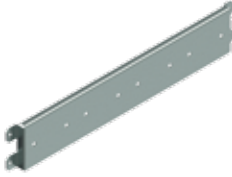

Selection table for covers, mounting plates, TH-S rails and fixing elements

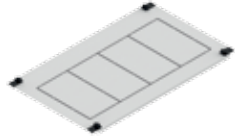
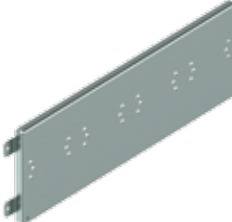
Type of equipment	Cover	Mounting plate	Fixing element
<p>Modular equipment (up to 125 A)</p> 	<p>CP x-1 M</p>  <p>CP x-1.5 M</p>  <p>page 73</p>	<p>TH-S x</p>  <p>page 80</p>	<p>1 set LG-V SET</p>  <p>page 91</p>
<p>HVL EK fuse-switch disconnectors with size NH00 (up to 160 A) with modular equipment (up to 125 A)</p> 	<p>CP x-2 H00 M</p>  <p>page 74</p>	<p>PM x H00 M</p>  <p>page 80</p>	<p>2 set LG-V SET</p>  <p>page 91</p>
<p>ED2 / EB2 disconnectors / circuit breakers (up to 250 A) with modular equipment (up to 125 A)</p> 	<p>CP x-2 E12 M</p>  <p>page 74</p>	<p>PM x E12 M</p>  <p>page 81</p>	<p>2 set LG-V SET</p>  <p>page 91</p>
<p>LBS1 type breakers (160 A) with modular equipment (up to 125 A)</p> 	<p>CP x-2 S1 M</p>  <p>page 75</p>	<p>PM x E12 M</p>  <p>page 81</p>	<p>2 set LG-V5 SET</p>  <p>page 91</p>
<p>KVL fuse-switch disconnectors with size NH00 (up to 160 A) with modular equipment (up to 125 A)</p> 	<p>CP x-2 K00</p>  <p>page 74</p>	<p>PM x K00</p>  <p>page 80</p>	<p>2 set LG-V SET</p>  <p>page 91</p>

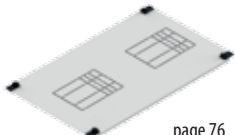

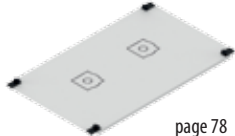
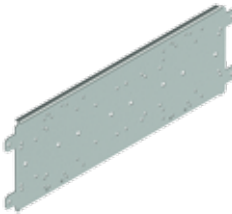









































Selection table for covers, mounting plates, TH-S rails and fixing elements

1 (250mm)	1.4 (350mm)	2 (500mm)	2.2 (550mm)	3 (750mm)	3.8 (950mm)	Fixing element	
12 mod.  CP 1-1 M 001101451  CP 1-1.5 M 001101458  TH-S 1 002911040	17 mod.  CP 1.4-1 M 001101452  CP 1.4-1.5 M 001101459  TH-S 1.4 002911041	24 mod.  CP 2-1 M 001101453  CP 2-1.5 M 001101459  TH-S 2 002911042	26 mod.  CP 2.2-1 M 001101454  CP 2.2-1.5 M 001101459  TH-S 2.2 002911043	36 mod.  CP 3-1 M 001101455  CP 3-1.5 M 001101460  TH-S 3 002911044	46 mod.  CP 3.8-1 M 001101456  CP 3.8-1.5 M 001101460  TH-S 3.8 002911045	1 set LG-V SET 001101683 1 set LG-V SET 001101683	1 (150mm) 1.5 (225mm)
1xHVL EK 00 NH00 4 mod.  CP 1-2 H00 M 001101474  PM 1 H00 M 001101563	1xHVL EK 00 NH00 5 mod.  CP 1.4-2 H00 M 001101475  PM 1.4 H00 M 001101564	2xHVL EK 00 NH00 9 mod.  CP 2-2 H00 M 001101476  PM 2 H00 M 001101565	2xHVL EK 00 NH00 10 mod.  CP 2.2-2 H00 M 001101477  PM 2.2 H00 M 001101566	3xHVL EK 00 NH00 16 mod.  CP 3-2 H00 M 001101478  PM 3 H00 M 001101567	4xHVL EK 00 NH00 21 mod.  CP 3.8-2 H00 M 001101479  PM 3.8 H00 M 001101568	2 set LG-V SET 001101683	2 (300mm)
1xEB2/ED2 3p do 250 A 4 mod.  CP 1-2 E12 M 3p 001101481  PM 1 E12 M 3P 001101570	1xEB2/ED2 3,4p do 250 A 4 mod.  CP 1.4-2 E12 M 001101482 1xLBS1 3,4p 160 A 4 mod.  CP 1.4-2 S1 M 001101720  PM 1.4 E12 M 001101571	1xEB2/ED2 3,4p do 250 A 12 mod.  CP 2-2 E12 M 001101483 1xLBS1 3,4p 160 A 12 mod.  CP 2-2 S1 M 001101721  PM 2 E12 M 001101572	1xEB2/ED2 3,4p do 250 A 14 mod.  CP 2.2-2 E12 M 001101484 1xLBS1 3,4p 160 A 14 mod.  CP 2.2-2 S1 M 001101722  PM 2.2 E12 M 001101573	1xEB2/ED2 3,4p do 250 A 25 mod.  CP 3-2 E12 M 001101485 1xLBS1 3,4p 160 A 25 mod.  CP 3-2 S1 M 001101723  PM 3 E12 M 001101574	1xEB2/ED2 3,4p do 250 A 36 mod.  CP 3.8-2 E12 M 001101486  PM 3.8 E12 M 001101575	2 set LG-V SET 001101683 2 set LG-V SET 001101685	2 (300mm) 2 (300mm)
1xKVL NH00 4 mod.  CP 1-2 K00 M 001339450  PM 1 K00 M 001340500	1xKVL NH00 5 mod.  CP 1.4-2 K00 M 001339451  PM 1.4 K00 M 001340501	2xKVL NH00 9 mod.  CP 2-2 K00 M 001339452  PM 2 K00 M 001340502	2xKVL NH00 10 mod.  CP 2.2-2 K00 M 001339453  PM 2.2 K00 M 001340503	3xKVL NH00 16 mod.  CP 3-2 K00 M 001339454  PM 3 K00 M 001340504		2 set LG-V SET 001101683	2 (300mm)











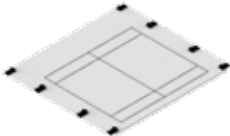
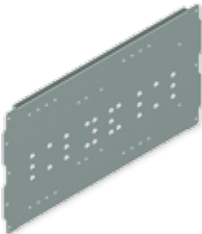

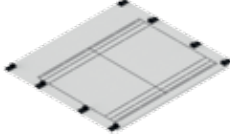
Selection table for covers, mounting plates, TH-S rails and fixing elements			
Type of equipment	Cover	Mounting plate	Fixing element
HVL EK fuse-switch disconnectors with size NH00 (up to 160 A)	 <p>CP x-2 H00</p>  <p>page 75</p>	 <p>PM x H00</p> <p>page 81</p>	<p>2 set LG-V SET</p>  <p>page 91</p>
KVL fuse-switch disconnectors with size NH00 (up to 160 A)	 <p>CP x-2 K00</p>  <p>page 75</p>	 <p>PM x K00</p> <p>page 82</p>	<p>2 set LG-V SET</p>  <p>page 91</p>
ED2 / EB2 disconnectors / circuit breakers (up to 250 A)	 <p>CP x-2 E12</p>  <p>page 76</p>		<p>2 set LG-V SET</p>  <p>page 91</p>
LBS1 type disconnectors (160 A)	 <p>CP x-2 S1</p>  <p>page 78</p>	 <p>PM1 x E12 L12</p> <p>page 82</p>	<p>2 set LG-V5 SET</p>  <p>page 91</p>
LBS2 type disconnectors (250 A)	 <p>CP x-2 S2</p>  <p>page 78</p>		<p>2 set LG-V5 SET</p>  <p>page 91</p>

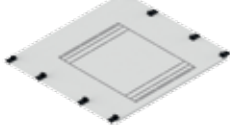

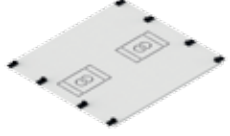
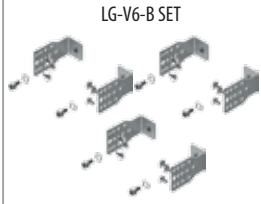

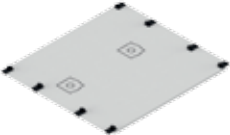

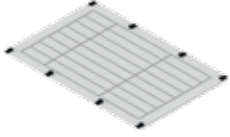
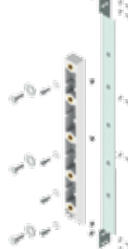







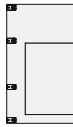







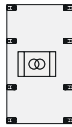
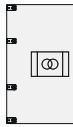



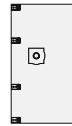

Selection table for covers, mounting plates, TH-S rails and fixing elements

1 (250 mm)	1.4 (350 mm)	2 (500 mm)	2.2 (550 mm)	3 (750 mm)	3.8 (950 mm)	Fixing element	
<p>1xHVL EK 00 NH00</p>  <p>CP 1-2 H00 001101488</p>  <p>PM 1 H00 001101577</p>	<p>2xHVL EK 00 NH00</p>  <p>CP 1.4-2 H00 001101489</p>  <p>PM 1.4 H00 001101578</p>	<p>4xHVL EK 00 NH00</p>  <p>CP 2-2 H00 001101490</p>  <p>PM 2 H00 001101579</p>	<p>4xHVL EK 00 NH00</p>  <p>CP 2.2-2 H00 001101491</p>  <p>PM 2.2 H00 001101580</p>	<p>6xHVL EK 00 NH00</p>  <p>CP 3-2 H00 001101492</p>  <p>PM 3 H00 001101581</p>	<p>8xHVL EK 00 NH00</p>  <p>CP 3.8-2 H00 001101493</p>  <p>PM 3.8 H00 001101582</p>	2 set LG-V SET 001101683	2 (300 mm)
<p>1xKVL NH00</p>  <p>CP 1-2 K00 001339500</p>  <p>PM 1 K00 001340550</p>	<p>2xKVL NH00</p>  <p>CP 1.4-2 K00 001339501</p>  <p>PM 1.4 K00 001340551</p>	<p>4xKVL NH00</p>  <p>CP 2-2 K00 001339502</p>  <p>PM 2 K00 001340552</p>	<p>4xKVL NH00</p>  <p>CP 2.2-2 K00 001339503</p>  <p>PM 2.2 K00 001340553</p>	<p>6xKVL NH00</p>  <p>CP 3-2 K00 001339504</p>  <p>PM 3 K00 001340554</p>		2 set LG-V SET 001101683	2 (300 mm)
<p>1xEB2/ED2 3,4p do 250 A</p>  <p>CP 1-2 E12 001101514</p> <p>1xLBS1 3,4p 160 A</p>  <p>CP 1-2 S1 001101725</p> <p>1xLBS2 3p 250 A</p>  <p>CP 1-2 S2 3P 001101731</p>  <p>PM 1 E12 L12 001101584</p>	<p>1xEB2/ED2 3,4p do 250 A</p>  <p>CP 1.4-2 E12 001101515</p> <p>1xLBS1 3,4p 160 A</p>  <p>CP 1.4-2 S1 001101726</p> <p>1xLBS2 3,4p 250 A</p>  <p>CP 1.4-2 S2 001101732</p>  <p>PM 1.4 E12 L12 001101585</p>	<p>2xEB2/ED2 3,4p do 250 A</p>  <p>CP 2-2 E12 001101516</p> <p>1xLBS1 3,4p 160 A</p>  <p>CP 2-2 S1 001101727</p> <p>2xLBS2 3p lub 1xLBS2 4p 250 A</p>  <p>CP 2-2 S2 001101733</p>  <p>PM 2 E12 L12 001101586</p>	<p>2xEB2/ED2 3,4p do 250 A</p>  <p>CP 2.2-2 E12 001101517</p> <p>1xLBS1 3,4p 160 A</p>  <p>CP 2.2-2 S1 001101728</p> <p>2xLBS2 3,4p 250 A</p>  <p>CP 2.2-2 S2 001101734</p>  <p>PM 2.2 E12 L12 001101587</p>	<p>3xEB2/ED2 3,4p do 250 A</p>  <p>CP 3-2 E12 001101518</p> <p>1xLBS1 3,4p 160 A</p>  <p>CP 3-2 S1 001101729</p> <p>3xLBS2 3p lub 2xLBS2 4p 250 A</p>  <p>CP 3-2 S2 001101735</p>  <p>PM 3 E12 L12 001101588</p>	<p>3xEB2/ED2 3,4p do 250 A</p>  <p>CP 3.8-2 E12 001101519</p>  <p>PM 3.8 E12 L12 001101589</p>	2 set LG-V SET 001101683	2 (300 mm)
						2 set LG-V SET 001101685	2 (300 mm)
						2 set LG-V SET 001101685	2 (300 mm)

* depending on the assembly method of LA1 disconnectors, the use of LG V5 allows the LA1 disconnector to be completely hidden under the CP cover.

Selection table for covers, mounting plates, TH-S rails and fixing elements			
Type of equipment	Cover	Mounting plate	Fixing element
KVL1 fuse-switch disconnectors with size NH1 (up to 250 A) 	CP x-3 K1  page 76	PM x ELS46 K123  page 83	3 set LG-V6-B SET  page 91
KVL1 fuse-switch disconnectors with size NH2 (up to 400 A) 	CP x-3 K2  page 76		3 set LG-V6-B SET  page 91
KVL1 fuse-switch disconnectors with size NH3 (up to 630 A) 	CP x-3 K3  page 76		3 set LG-V6-B SET  page 91
EB2 / ED2 disconnectors / circuit breakers (400, 630 A) 	CP x-3 E46  page 77		3 set LG-V6-B SET 
LBS 46 type disconnectors (400, 630 A) 	CP x-3 S46  page 78		2 set LG-V6-D SET  page 91
SL strip type fuse-switch disconnectors size NH00, 1, 2, 3 (do 630 A) 	CP x-5 SL  page 79		LG-T-B185-H P3  page 93

Selection table for covers, mounting plates, TH-S rails and fixing elements

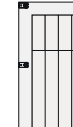
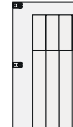
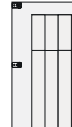
1 (250 mm)	1.4 (350 mm)	2 (500 mm)	2.2 (550 mm)	3 (750 mm)	3.8 (950 mm)	Fixing element
<p>1xKVL1 NH1</p>  <p>CP 1-3 K1 001339550</p>	<p>1xKVL1 NH1</p>  <p>CP 1.4-3 K1 001339551</p>	<p>2xKVL1 NH1</p>  <p>CP 2-3 K1 001339552</p>	<p>2xKVL1 NH1</p>  <p>CP 2.2-3 K1 001339553</p>	<p>3xKVL1 NH1</p>  <p>CP 3-3 K1 001339554</p>		<p>3 set LG-V6-B SET 001341151</p> <p>3 (450 mm)</p>
	<p>1xKVL2 NH2</p>  <p>CP 1.4-3 K2 001339600</p>	<p>2xKVL2 NH2</p>  <p>CP 2-3 K2 001339601</p>	<p>2xKVL2 NH2</p>  <p>CP 2.2-3 K2 001339602</p>	<p>3xKVL2 NH2</p>  <p>CP 3-3 K2 001339603</p>		<p>3 set LG-V6-B SET 001341151</p> <p>3 (450 mm)</p>
	<p>1xKVL3 NH3</p>  <p>CP 1.4-3 K3 001339650</p>	<p>1xKVL3 NH3</p>  <p>CP 2-3 K3 001339651</p>	<p>1xKVL3 NH3</p>  <p>CP 2.2-3 K3 001339652</p>	<p>2xKVL3 NH3</p>  <p>CP 3-3 K3 001339653</p>		<p>3 set LG-V6-B SET 001341151</p> <p>3 (450 mm)</p>
<p>1xEB2/ED2 3,4p do 630 A</p>  <p>CP 1-3 E46 001339300</p>	<p>1xEB2/ED2 3,4p do 630 A</p>  <p>CP 1.4-3 E46 001339301</p>	<p>2xEB2/ED2 3,4p do 630 A</p>  <p>CP 2-3 E46 001339302</p>	<p>2xEB2/ED2 3,4p do 630 A</p>  <p>CP 2.2-3 E46 001339303</p>	<p>3xEB2/ED2 3,4p do 630 A</p>  <p>CP 3-3 E46 001339304</p>		<p>3 set LG-V6-B SET 001341151</p> <p>3 (450 mm)</p>
<p>1xLBS46 3p 400, 630 A</p>  <p>CP 1-3 S46 3P 001339700</p>	<p>1xLBS46 3,4p 400, 630 A</p>  <p>CP 1.4-3 S46 001339701</p>	<p>2xLBS46 3p or 1xLBS46 4p 400, 630 A</p>  <p>CP 2-3 S46 001339702</p>	<p>2xLBS46 3p or 1xLBS46 4p 400, 630 A</p>  <p>CP 2.2-3 S46 001339703</p>	<p>3xLBS46 3p or 1xLBS46 4p 400, 630 A</p>  <p>CP 3-3 S46 001339704</p>		<p>3 set LG-V6-D SET 001341153</p> <p>3 (450 mm)</p>
<p>PM 1 ELS46 K1 001340700</p> 	<p>PM 1.4 ELS46 K123 001340701</p> 	<p>PM 2 ELS46 K123 001340702</p> 	<p>PM 2.2 ELS46 K123 001340703</p> 	<p>PM 3 ELS46 K123 001340704</p> 		
<p>2xSL 00 1xSL 1,2,3</p>  <p>CP 1-5 SL 001339750</p>	<p>4xSL 00 2xSL 1,2,3</p>  <p>CP 1.4-5 SL 001339751</p>	<p>8xSL 00 4xSL 1,2,3</p>  <p>CP 2-5 SL 001339752</p>	<p>8xSL 00 4xSL 1,2,3</p>  <p>CP 2.2-5 SL 001339753</p>	<p>12xSL 00 6xSL 1,2,3</p>  <p>CP 3-5 SL 001339754</p>		<p>LG-T-B185-H3 001341850</p> <p>5 (750 mm)</p>

Plain metal covers

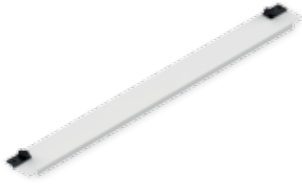

Plain covers - height 50 mm				
Type	Description	Code nr	Weight (kg)	Packaging (pcs)
CP 1-0.33 F	Plain cover (250x50)	001101420	0,12	1
CP 1.4-0.33 F	Plain cover (350x50)	001101421	0,14	1
CP 2.2-0.33 F	Plain cover (550x50)	001101422	0,23	1
CP 3-0.33 F	Plain cover (750x50)	001101423	0,31	1
CP 3.8-0.33 F	Plain cover (950x50)	001101424	0,39	1

Assembly instructions: CP X-Y F



Plain covers - height 75 mm				
Type	Description	Code nr	Weight (kg)	Packaging (pcs)
CP 1-0.5 F	Plain cover (250x75)	001101425	0,15	1
CP 2-0.5 F	Plain cover (500x75)	001101426	0,30	1
CP 3-0.5 F	Plain cover (750x75)	001101427	0,45	1

Assembly instructions: CP X-Y F



Plain covers - height 150 mm				
Type	Description	Code nr	Weight (kg)	Packaging (pcs)
CP 1-1 F	Plain cover (250x150)	001101429	0,28	1
CP 1.4-1 F	Plain cover (350x150)	001101430	0,39	1
CP 2-1 F	Plain cover (500x150)	001101431	0,55	1
CP 2.2-1 F	Plain cover (550x150)	001101432	0,61	1
CP 3-1 F	Plain cover (750x150)	001101433	0,83	1
CP 3.8-1 F	Plain cover (950x150)	001101434	1,05	1

Assembly instructions: CP X-Y F



Plain covers - height 300 mm				
Type	Description	Code nr	Weight (kg)	Packaging (pcs)
CP 1-2 F	Plain cover (250x300)	001101436	0,52	1
CP 1.4-2 F	Plain cover (350x300)	001101437	0,73	1
CP 2-2 F	Plain cover (500x300)	001101438	1,05	1
CP 2.2-2 F	Plain cover (550x300)	001101439	1,15	1
CP 3-2 F	Plain cover (750x300)	001101440	1,57	1
CP 3.8-2 F	Plain cover (950x300)	001101441	1,99	1

Assembly instructions: CP X-Y F

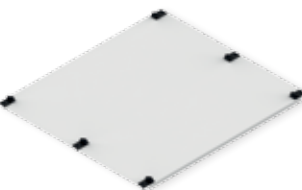

Plain covers - height 450 mm				
Type	Description	Code nr	Weight (kg)	Packaging (pcs)
CP 1-3 F	Plain cover (250x450)	001101443	0,77	1
CP 2-3 F	Plain cover (500x450)	001101444	1,55	1
CP 3-3 F	Plain cover (750x450)	001101445	2,32	1

Assembly instructions: CP X-Y F

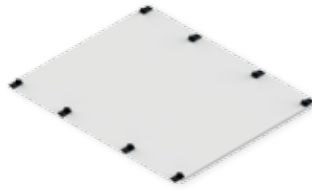

Plain covers - height 600 mm				
Type	Description	Code nr	Weight (kg)	Packaging (pcs)
CP 1-4 F	Plain cover (250x600)	001101447	1,02	1
CP 2-4 F	Plain cover (500x600)	001101448	2,04	1
CP 3-4 F	Plain cover (750x600)	001101449	3,06	1

Assembly instructions: CP X-Y F

Universal covers with plastic filling

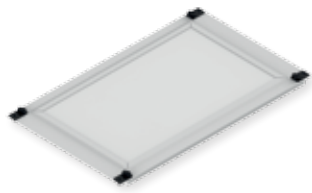

Universal covers with plastic filling for self-cutting - height 300 mm				
Type	Description	Code nr	Weight (kg)	Packaging (pcs)
CP 1-2 PF	Universal cover with plastic filling (250x300)	001340050	0,41	1
CP 1.4-2 PF	Universal cover with plastic filling (350x300)	001340051	0,55	1
CP 2-2 PF	Universal cover with plastic filling (500x300)	001340052	0,84	1
CP 2.2-2 PF	Universal cover with plastic filling (550x300)	001340053	0,78	1
CP 3-2 PF	Universal cover with plastic filling (750x300)	001340054	1,01	1

Assembly instructions: CP X-Y PF

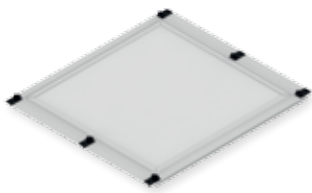

Universal covers with plastic filling for self-cutting - height 400 mm				
Type	Description	Code nr	Weight (kg)	Packaging (pcs)
CP 1-3 PF	Universal cover with plastic filling (250x450)	001340056	0,63	1
CP 1.4-3 PF	Universal cover with plastic filling (350x450)	001340057	0,77	1
CP 2-3 PF	Universal cover with plastic filling (500x450)	001340058	0,99	1
CP 2.2-3 PF	Universal cover with plastic filling (550x450)	001340059	1,07	1
CP 3-3 PF	Universal cover with plastic filling (750x450)	001340060	1,36	1

Assembly instructions: CP X-Y PF

Modular equipment covers



Modular cover - height 150 mm				
Type	Description	Code nr	Weight (kg)	Packaging (pcs)
CP 1-1 M	Modular cover 12 mod. (250x150)	001101451	0,21	1
CP 1.4-1 M	Modular cover 17 mod. (350x150)	001101452	0,29	1
CP 2-1 M	Modular cover 24 mod. (500x150)	001101453	0,42	1
CP 2.2-1 M	Modular cover 26 mod. (550x150)	001101454	0,46	1
CP 3-1 M	Modular cover 36 mod. (750x150)	001101455	0,63	1
CP 3.8-1 M	Modular cover 46 mod. (950x150)	001101456	0,79	1

Assembly instructions: CP X-1 M



Modular cover - height 225 mm				
Type	Description	Code nr	Weight (kg)	Packaging (pcs)
CP 1-1.5 M	Modular cover 12 mod. (250x225)	001101458	0,33	1
CP 2-1.5 M	Modular cover 24 mod. (500x225)	001101459	0,67	1
CP 3-1.5 M	Modular cover 36 mod. (750x225)	001101460	1,00	1

Assembly instructions: CP X-1.5 M

Covers for HVL EK disconnectors and modular equipment

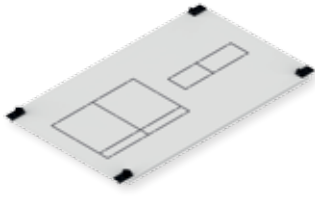

Covers for HVL EK 00 disconnectors and modular equipment - height 300 mm				
Type	Description	Code nr	Weight (kg)	Packaging (pcs)
CP 1-2 H00 M	Cover 1xHVL EK 00 in 4 mod. (250x300)	001101474	0,52	1
CP 1.4-2 H00 M	Cover 1xHVL EK 00 in 5 mod. (350x300)	001101475	0,72	1
CP 2-2 H00 M	Cover 2xHVL EK 00 in 9 mod. (500x300)	001101476	1,03	1
CP 2.2-2 H00 M	Cover 2xHVL EK 00 in 10 mod. (550x300)	001101477	1,14	1
CP 3-2 H00 M	Cover 3xHVL EK 00 in 16 mod. (750x300)	001101478	1,55	1
CP 3.8-2 H00 M	Cover 4xHVL EK 00 in 21 mod. (950x300)	001101479	1,96	1

The covers should be completed with a dedicated PM H00 M mounting plate:
 Assembly instructions: CP X-2 H00 M

Note: HVL EK 00 disconnector covers available while stocks last.

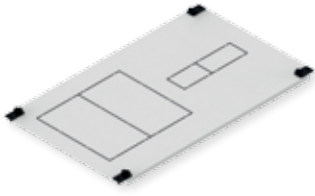

Covers for KVL00 disconnectors and modular equipment - height 300 mm				
Type	Description	Code nr	Weight (kg)	Packaging (pcs)
CP 1-2 K00 M	Cover 1xKVL00 in 4 mod. (250x300)	001339450	0,48	1
CP 1.4-2 K00 M	Cover 1xKVL00 in 5 mod. (350x300)	001339451	0,68	1
CP 2-2 K00 M	Cover 2xKVL00 in 9 mod. (500x300)	001339452	1,06	1
CP 2.2-2 K00 M	Cover 2xKVL00 in 10 mod. (550x300)	001339453	1,07	1
CP 3-2 K00 M	Cover 3xKVL00 in 16 mod. (750x300)	001339454	1,58	1

The covers should be completed with a dedicated PM K00 M mounting plate
 Assembly instructions: CP X-2 K00 M

Covers for ED2 disconnectors / EB2 circuit breakers and modular equipment

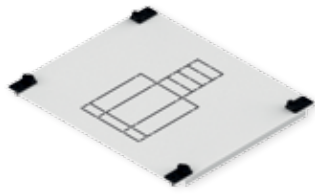

Cover for ED2 / EB2 125,160,250 3P disconnectors and circuit breakers and modular equipment - height 300 mm				
Type	Description	Code nr	Weight (kg)	Packaging (pcs)
CP 1-2 E12 M 3P	Cover 1xEB2/ED2 125,160,250A 3P in 4 mod. (250x300)	001101481	0,51	1

The cover should be completed with a dedicated PM 1 E12 M 3P mounting plate:
 Assembly instructions: CP 1-2 E12 M 3P

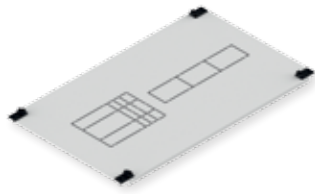

Cover for ED2 / EB2 125,160,250 4P disconnectors and circuit breakers and modular equipment - height 300 mm				
Type	Description	Code nr	Weight (kg)	Packaging (pcs)
CP 1.4-2 E12 M	Cover 1xEB2/ED2 125,160,250A 3,4P in 4 mod. (350x300)	001101482	0,72	1
CP 2-2 E12 M	Cover 1xEB2/ED2 125,160,250A 3,4P in 12 mod. (500x300)	001101483	1,03	1
CP 2.2-2 E12 M	Cover 1xEB2/ED2 125,160,250A 3,4P in 14 mod. (550x300)	001101484	1,13	1
CP 3-2 E12 M	Cover 1xEB2/ED2 125,160,250A 3,4P in 25 mod. (750x300)	001101485	1,54	1
CP 3.8-2 E12 M	Cover 1xEB2/ED2 125,160,250A 3,4P in 36 mod. (950x300)	001101486	1,95	1

The covers should be completed with a dedicated PM E12 M mounting plate:
 Assembly instructions: CP X-2 E12 M

Covers for LBS disconnectors and modular equipment

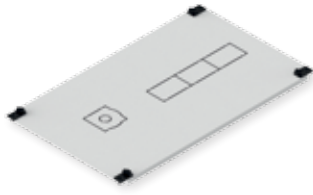

Covers for LBS disconnectors and modular equipment - height 300 mm

Type	Description	Code nr	Weight (kg)	Packaging (pcs)
CP 1.4-2 S1 M	Cover 1xLBS 160A 3,4P in 4 mod. (350x300)	001101720	0,72	1
CP 2-2 S1 M	Cover 1xLBS 160A 3,4P in 12 mod. (500x300)	001101721	1,03	1
CP 2.2-2 S1 M	Cover 1xLBS 160A 3,4P in 14 mod. (550x300)	001101722	1,13	1
CP 3-2 S1 M	Cover 1xLBS 160A 3,4P in 25 mod. (750x300)	001101723	1,55	1

The covers should be completed with a dedicated PM E12 M mounting plate:
Installation instructions: CP X-2 S1 M

Covers for HVL EK 00 fuse-switch disconnectors

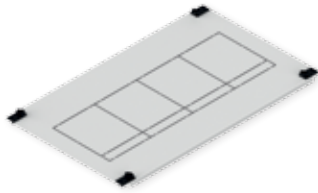

Covers for HVL EK 00 fuse-switch disconnectors - height 300 mm

Type	Description	Code nr	Weight (kg)	Packaging (pcs)
CP 1-2 H00	Cover 1xHVL EK 00 (250x300)	001101488	0,52	1
CP 1.4-2 H00	Cover 2xHVL EK 00 (350x300)	001101489	0,72	1
CP 2-2 H00	Cover 4xHVL EK 00 (500x300)	001101490	1,03	1
CP 2.2-2 H00	Cover 4xHVL EK 00 (550x300)	001101491	1,13	1
CP 3-2 H00	Cover 6xHVL EK 00 (750x300)	001101492	1,55	1
CP 3.8-2 H00	Cover 8xHVL EK 00 (950x300)	001101493	1,96	1

The covers should be completed with a dedicated PM H00 mounting plate
Assembly instructions: CP X-2 H00

Note: HVL EK 00 disconnector covers available while stocks last.

Covers for KVL 00 fuse-switch disconnectors

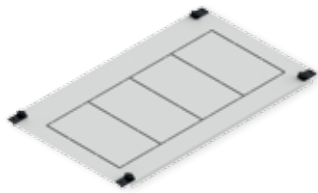

Covers for KVL 00 fuse-switch disconnectors - height 300 mm

Type	Description	Code nr	Weight (kg)	Packaging (pcs)
CP 1-2 K00	Cover 1xKVL00 (250x300)	001339500	0,53	1
CP 1.4-2 K00	Cover 2xKVL00 (350x300)	001339501	0,68	1
CP 2-2 K00	Cover 4xKVL00 (500x300)	001339502	1,07	1
CP 2.2-2 K00	Cover 4xKVL00 (550x300)	001339503	1,07	1
CP 3-2 K00	Cover 6xKVL00 (750x300)	001339504	1,58	1

The covers should be completed with a dedicated PM K00 mounting plate
Assembly instructions: CP X-2 K00

KVL fuse-switch disconnectors covers for sizes 1,2,3

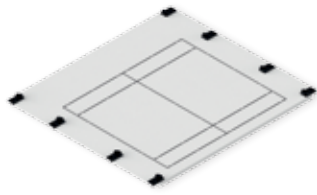

Covers for KVL 1 fuse-switch disconnectors - height 450 mm				
Type	Description	Code nr	Weight (kg)	Packaging (pcs)
CP 1-3 K1	Cover 1xKVL1 (250x450)	001339550	0,70	1
CP 1.4-3 K1	Cover 1xKVL1 (350x450)	001339551	1,00	1
CP 2-3 K1	Cover 2xKVL1 (500x450)	001339552	1,79	1
CP 2.2-3 K1	Cover 2xKVL1 (550x450)	001339553	1,58	1
CP 3-3 K1	Cover 3xKVL1 (750x450)	001339554	2,33	1

The covers should be completed with a dedicated PM ... ELS46 K123 mounting plate:
 Assembly instructions: CP x-3 K1

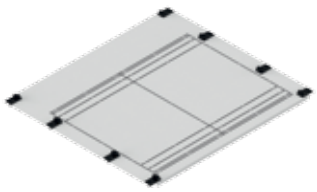

Covers for KVL 2 fuse-switch disconnectors - height 450 mm				
Type	Description	Code nr	Weight (kg)	Packaging (pcs)
CP 1.4-3 K2	Cover 1xKVL2 (350x450)	001339600	0,99	1
CP 2-3 K2	Cover 2xKVL2 (500x450)	001339601	1,41	1
CP 2.2-3 K2	Cover 2xKVL2 (550x450)	001339602	1,55	1
CP 3-3 K2	Cover 3xKVL2 (750x450)	001339603	2,33	1

The covers should be completed with a dedicated PM ... ELS46 K123 mounting plate:
 Assembly instructions: CP x-3 K2

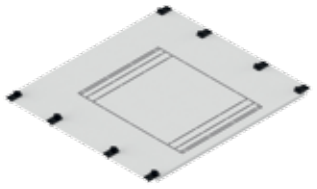

Covers for KVL 3 fuse-switch disconnectors - height 450 mm				
Type	Description	Code nr	Weight (kg)	Packaging (pcs)
CP 1.4-3 K3	Cover 1xKVL3 (350x450)	001339650	0,99	1
CP 2-3 K3	Cover 1xKVL3 (500x450)	001339651	1,43	1
CP 2.2-3 K3	Cover 1xKVL3 (550x450)	001339652	1,57	1
CP 3-3 K3	Cover 2xKVL3 (750x450)	001339653	2,34	1

The covers should be completed with a dedicated PM ... ELS46 K123 mounting plate:
 Assembly instructions: CP x-3 K3

ED2 / EB2 (125, 160, 250 A) disconnectors and circuit breakers

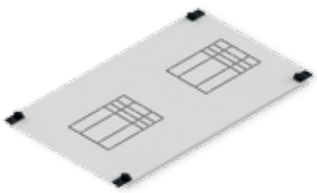

ED2 / EB2 125, 160, 250 A 3, 4P disconnectors and circuit breakers - height 300 mm				
Type	Description	Code nr	Weight (kg)	Packaging (pcs)
CP 1-2 E12	Cover 1xEB2/ED2 125,160,250A 3,4P (250x300)	001101514	0,51	1
CP 1.4-2 E12	Cover 1xEB2/ED2 125,160,250A 3,4P (350x300)	001101515	0,72	1
CP 2-2 E12	Cover 2xEB2/ED2 125,160,250A 3,4P (500x300)	001101516	1,02	1
CP 2.2-2 E12	Cover 2xEB2/ED2 125,160,250A 3,4P (550x300)	001101517	1,13	1
CP 3-2 E12	Cover 3xEB2/ED2 125,160,250A 3,4P (750x300)	001101518	1,53	1
CP 3.8-2 E12	Cover 3xEB2/ED2 125,160,250A 3,4P (950x300)	001101519	1,95	1

The covers should be completed with a dedicated PM E12 L12 mounting plate
 Assembly instructions: CP X-2 E12

ED2 / EB2 (400, 630 A) disconnectors and circuit breakers

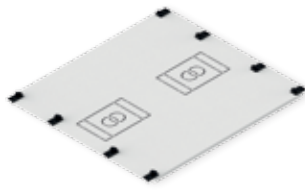

Covers for EB2 / ED2 400, 630 A 3,4P disconnectors and circuit breakers - height 450 mm

Type	Description	Code nr	Weight (kg)	Packaging (pcs)
CP 1-3 E46	Cover 1xEB2/ED2 400, 630A 3,4P (250x450)	001339300	0,72	1
CP 1.4-3 E46	Cover 1xEB2/ED2 400, 630A 3,4P (350x450)	001339301	1,01	1
CP 2-3 E46	Cover 2xEB2/ED2 400, 630A 3,4P (500x450)	001339302	1,44	1
CP 2.2-3 E46	Cover 2xEB2/ED2 400, 630A 3,4P (550x450)	001339303	1,58	1
CP 3-3 E46	Cover 3xEB2/ED2 400, 630A 3,4P (750x450)	001339304	2,35	1

The covers should be completed with a dedicated PM ... ELS46 K123 mounting plate
 Assembly instructions: CP X-3 E46

Covers for LBS1,2,3,4 (160-630 A) disconnectors

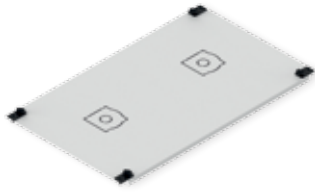

Covers for LBS 160 A disconnectors - height 300 mm				
Type	Description	Code nr	Weight (kg)	Packaging (pcs)
CP 1-2 S1	Cover 1xLBS 160A 3,4P (250x300)	001101725	0,52	1
CP 1.4-2 S1	Cover 1xLBS 160A 3,4P (350x300)	001101726	0,73	1
CP 2-2 S1	Cover 2xLBS 160A 3,4P (500x300)	001101727	1,04	1
CP 2.2-2 S1	Cover 2xLBS 160A 3,4P (550x300)	001101728	1,15	1
CP 3-2 S1	Cover 3xLBS 160A 3,4P (750x300)	001101729	1,57	1

The covers should be completed with a dedicated PM E12 L12 mounting plate
 Assembly instructions: CP X-2 S1

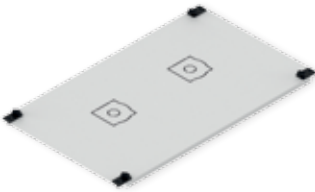

Covers for LBS 250 A disconnectors - heigh 300 mm				
Type	Description	Code nr	Weight (kg)	Packaging (pcs)
CP 1-2 S2 3P	Cover 1xLBS 250A 3P (250x300)	001101731	0,52	1
CP 1.4-2 S2	Cover 1xLBS 250A 3,4P (350x300)	001101732	0,73	1
CP 2-2 S2	Cover 2xLBS 250A 3P lub 1xLBS 250A 4P (500x300)	001101733	1,04	1
CP 2.2-2 S2	Cover 2xLBS 250A 3,4P (550x300)	001101734	1,15	1
CP 3-2 S2	Cover 3xLBS 250A 3P lub 2xLBS 250A 4P (750x300)	001101735	1,57	1

The covers should be completed with a dedicated PM ... E12 L12 mounting plate
 Assembly instructions: CP X-2 S2

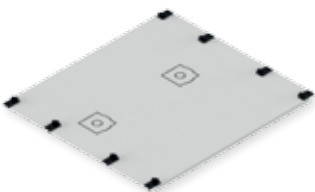

Covers for LBS 400, 630 A disconnectors - heigh 450 mm				
Type	Description	Code nr	Weight (kg)	Packaging (pcs)
CP 1-3 S46 3P	Cover 1xLBS 400, 630A 3P (250x450)	001339700	0,72	1
CP 1.4-3 S46	Cover 1xLBS 400, 630A 3,4P (350x450)	001339701	1,02	1
CP 2-3 S46	Cover 2xLBS 400, 630A 3P lub 1xLBS 400, 630A 4P (500x450)	001339702	1,45	1
CP 2.2-3 S46	Cover 2xLBS 400, 630A 3P lub 1xLBS 400, 630A 4P (550x450)	001339703	1,60	1
CP 3-3 S46	Cover 3xLBS 400, 630A 3P lub 1xLBS 400, 630A 4P (750x450)	001339704	2,39	1

The covers should be completed with a dedicated PM ... ELS46 K123 mounting plate
 Assembly instructions: CP X-3 S46

Covers for SL strip type fuse-switch disconnectors SL00,1,2,3 (2-630 A)

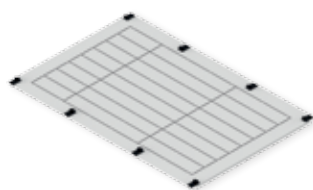

Covers for SL strip type fuse-switch disconnectors (20 - 630 A)				
Type	Description	Code nr	Weight (kg)	Packaging (pcs)
CP 1-5 SL	Cover 2xSL00 lub 1xSL1,2,3 (250x750)	001339750	1,17	1
CP 1.4-5 SL	Cover 4xSL00 lub 2xSL1,2,3 (350x750)	001339751	1,63	1
CP 2-5 SL	Cover 8xSL00 lub 4xSL1,2,3 (500x750)	001339752	2,31	1
CP 2.2-5 SL	Cover 8xSL00 lub 4xSL1,2,3 (550x750)	001339753	2,55	1
CP 3-5 SL	Cover 12xSL00 lub 6xSL1,2,3 (750x750)	001339754	3,77	1

Assembly instructions: CP X-5 SL

Additional covers to complement the front of the HXS enclosures



Side vertical additional covers				
Type	Description	Code nr	Weight (kg)	Packaging (pcs)
CP-BV 12	Side additional covers, sleft and right, for HXS enclosures, height 12 (1800) (1kpl.)	001340164	0,99	1
CP-BV 13	Side additional covers, sleft and right, for HXS enclosures, height 13 (1950) (1kpl.)	001340165	1,09	1

The set includes: a set of side covers (left and right) for enclosures and a set of self-tapping screws
 Assembly instructions: CP-BV



Horizontal upper and lower additional covers - not separated				
Type	Description	Code nr	Weight (kg)	Packaging (pcs)
CP-BHS 2	Horizontal, upper and lower horizontal additional covers, for HXS enclosures, width 2 (500) (1kpl.)	001340252	0,25	1
CP-BHS 3	Horizontal, upper and lower horizontal additional covers, for HXS enclosures, width 3 (750) (1kpl.)	001340254	0,37	1

The set includes: a pair of not separated additional covers (top and bottom) for enclosures with no internal division and a set of self-tapping screws.
 Assembly instructions: CP-BHS

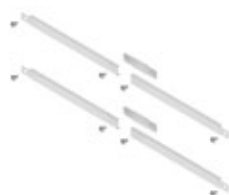

Horizontal upper and lower additional covers - divided				
Type	Description	Code nr	Weight (kg)	Packaging (pcs)
CP-BH 2	Divided horizontal additional covers, top and bottom, for HXS enclosures, width 2 (500) (1 set)	001340200	0,29	1
CP-BH 3	Divided horizontal additional covers, top and bottom, for HXS enclosures, width 3 (750) (1 set)	001340201	0,43	1
CP-BH 4	Divided horizontal additional covers, top and bottom, for HXS enclosures, width 4 (1000) (1 set)	001340202	0,58	1

Includes: set of additional covers (upper and lower) divided with connecting elements for enclosures with an internal division of the internal set and a set of self-tapping screws
 Assembly instructions: CP-BH

TH mounting rails



TH mounting rails				
Type	Description	Code nr	Weight (kg)	Packaging (pcs)
TH-S 1	Mounting rail 35/15 1.5 steel 215 mm (250)	002911040	0,15	1
TH-S 1.4	Mounting rail 35/15 1.5 steel 315 mm (350)	002911041	0,21	1
TH-S 2	Mounting rail 35/15 1.5 steel 465 mm (500)	002911042	0,32	1
TH-S 2.2	Mounting rail 35/15 1.5 steel 515 mm (550)	002911043	0,35	1
TH-S 3	Mounting rail 35/15 1.5 steel 715 mm (750)	002911044	0,49	1
TH-S 3.8	Mounting rail 35/15 1.5 steel 915 mm (950)	002911045	0,62	1

Selection of the rail length depending on the width of the assembly pole.

To mount TH-S rails on WP-A supports, depending on the required installation depth, use:

1 x LG-V SET - modular equipment

1 x LG-V5 SET - serial terminals

To mount the TH-S rail on the LG-V6 fixing elements, drill the mounting holes with a Ø6 drill

Mounting plates for HVL EK 00 disconnectors and modular equipment

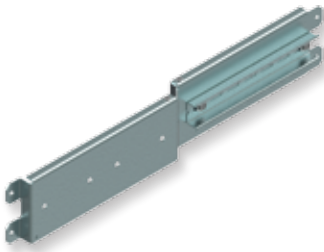

Mounting plates for HVL EK 00 disconnectors and modular equipment				
Type	Description	Code nr	Weight (kg)	Packaging (pcs)
PM 1 H00 M	Mounting plate 1xHVL EK 00 with TH35 rail for 4 mod. (250)	001101563	0,31	1
PM 1.4 H00 M	Mounting plate 1xHVL EK 00 with TH35 rail for 5 mod. (350)	001101564	0,53	1
PM 2 H00 M	Mounting plate 1xHVL EK 00 with TH35 rail for 9 mod. (500)	001101565	0,79	1
PM 2.2 H00 M	Mounting plate 1xHVL EK 00 with TH35 rail for 10 mod. (550)	001101566	0,88	1
PM 3 H00 M	Mounting plate 1xHVL EK 00 with TH35 rail for 16 mod. (750)	001101567	1,31	1
PM 3.8 H00 M	Mounting plate 1xHVL EK 00 with TH35 rail for 21 mod. (950)	001101568	1,57	1

To mount one piece of the HVL EK 00 disconnector on the mounting plate, you should purchase:

- M6x16 DIN 933 screw (AS-H 6x16) - 2 pcs.
- M6 washer DIN 126 (AW-R 6) - 4 pct.
- M6 spring washer DIN 127 (AW-S 6) - 2 pcs.
- M6 nut DIN 934 (AN-H 6) - 2 pcs.

Assembly instructions: CP X-2 H00 M

To mount the PM x H00 M mounting plate on the LG-V6 fixing elements, drill the mounting holes with a Ø6 drill

Note: mounting plates for HVL EK 00 disconnectors available while stocks last.

Mounting plates for KVL00 disconnectors and modular equipment



Mounting plates for KVL00 disconnectors and modular equipment				
Type	Description	Code nr	Weight (kg)	Packaging (pcs)
PM 1 K00 M	Mounting plate 1xKVL00 with TH35 rail for 4 mod. (250)	001340500	0,57	1
PM 1.4 K00 M	Mounting plate 1xKVL00 with TH35 rail for 5 mod. (350)	001340501	1,03	1
PM 2 K00 M	Mounting plate 1xKVL00 with TH35 rail for 9 mod. (500)	001340502	1,40	1
PM 2.2 K00 M	Mounting plate 1xKVL00 with TH35 rail for 10 mod. (550)	001340503	1,61	1
PM 3 K00 M	Mounting plate 1xKVL00 with TH35 rail for 16 mod. (750)	001340504	2,20	1

To attach one piece of KVL00 disconnector to the mounting plate, you should buy:

- M6x16 DIN 933 screw (AS-H 6x16) - 4 pcs.
- M6 washer DIN 126 (AW-R 6) - 8 pcs
- M6 spring washer DIN 127 (AW-S 6) - 4 pcs.
- M6 nut DIN 934 (AN-H 6) - 4 pcs.

Assembly instructions: CP X-2 K00 M

To mount the PM x K00 M mounting plate on the LG-V6 fixing elements, drill the mounting holes with a Ø6 drill

Mounting plates for ED2 / EB2 disconnectors / circuit breakers (125, 160, 250 A) or LBS disconnectors (160 A) and modular equipment

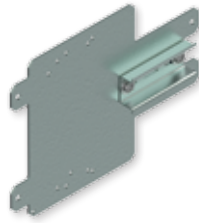

Mounting plates for ED2 / EB2 disconnectors / circuit breakers 125, 160, 250 3P or LBS disconnectors 160 3P and modular equipment

Type	Description	Code nr	Weight (kg)	Packaging (pcs)
PM 1 E12 M 3P	1x EB2 / ED2 3P mounting plate with TH35 rail for 4 mod. (250)	001101570	0,43	1

To attach one piece of the EB2 / ED2 disconnector / circuit breaker in the 3P version on the mounting plate, you should buy:

- washer M4 DIN 126 (AW-R 4) - 2 pcs.
- spring washer M4 DIN 127 (AW-S 4) - 2 pcs.
- nut M4 DIN 934 (AN-H 4) - 2 pcs.

Mounting screws included with the equipment.
Assembly instructions: CP 1-2 E12 M 3P

To attach one piece of LBS 160, 250A 3,4P, you should buy:

- metric Allen screw-M5x50 (AS-SH 5x50) - 4 pcs.
- washer M5 DIN 126 (AW-R 5) - 8 pcs.
- spring washer M5 DIN 127 (AW-S 5) - 4 pcs.
- nut M5 DIN 934 (AN-H 5) - 4 pcs.

Assembly instructions: CP X-2 LBS12

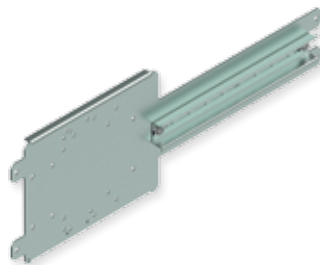

Mounting plates for ED2 / EB2 disconnectors / circuit breakers 125, 160, 250 4P or LBS disconnectors 160 4P and modular equipment

Type	Description	Code nr	Weight (kg)	Packaging (pcs)
PM 1.4 E12 M	1x EB2 / ED2 mounting plate with TH35 rail for 4 mod. (350)	001101571	0,68	1
PM 2 E12 M	1x EB2 / ED2 mounting plate with TH35 rail for 12 mod. (500)	001101572	0,94	1
PM 2.2 E12 M	1x EB2 / ED2 mounting plate with TH35 rail for 14 mod. (550)	001101573	1,03	1
PM 3 E12 M	1x EB2 / ED2 mounting plate with TH35 rail for 25 mod. (750)	001101574	1,36	1
PM 3.8 E12 M	1x EB2 / ED2 mounting plate with TH35 rail for 36 mod. (950)	001101575	1,70	1

To attach one piece of the EB2 / ED2 disconnector / circuit breaker in the 3P version on the mounting plate, you should buy:

3P version:

- washer M4 DIN 126 (AW-R 4) - 2 pcs.
- spring washer M4 DIN 127 (AW-S 4) - 2 pcs.
- nut M4 DIN 934 (AN-H 4) - 2 pcs.

4P version:

- washer M4 DIN 126 (AW-R 4) - 4 pcs.
- spring washer M4 DIN 127 (AW-S 4) - 4 pcs.
- nut M4 DIN 934 (AN-H 4) - 4 pcs.

Mounting screws included with the equipment.

Assembly instructions: CP X-2 E12 M

To mount the PM x E12 M mounting plate on the LG-V6 fixing elements, drill the mounting holes with a Ø6 drill

To attach one piece of LBS 160, 250A 3,4P, you should buy:

- metric Allen screw-M5x50 (AS-SH 5x50) - 4 pcs.
- washer M5 DIN 126 (AW-R 5) - 8 pcs.
- spring washer M5 DIN 127 (AW-S 5) - 4 pcs.
- nut M5 DIN 934 (AN-H 5) - 4 pcs.

Assembly instructions: CP X-2 LBS12

Mounting plates for HVL EK 00 disconnectors

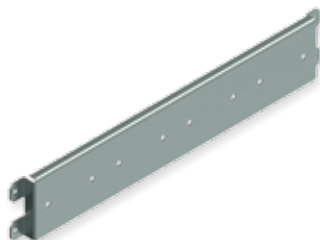

Mounting plates for HVL EK 00 disconnectors

Type	Description	Code nr	Weight (kg)	Packaging (pcs)
PM 1 H00	Mounting plate 1xHVL EK 00 (250)	001101577	0,32	1
PM 1.4 H00	Mounting plate 2xHVL EK 00 (350)	001101578	0,46	1
PM 2 H00	Mounting plate 4xHVL EK 00 (500)	001101579	0,70	1
PM 2.2 H00	Mounting plate 4xHVL EK 00 (550)	001101580	0,78	1
PM 3 H00	Mounting plate 6xHVL EK 00 (750)	001101581	1,08	1
PM 3.8 H00	Mounting plate 8xHVL EK 00 (950)	001101582	1,39	1

To mount one piece of the HVL EK 00 disconnector on the mounting plate, you should purchase:

- screw M6x16 DIN 933 (AS-H 6x16) - 2 pcs.
- washer M6 DIN 126 (AW-R 6) - 4 items
- spring washer M6 DIN 127 (AW-S 6) - 2 pcs.
- nut M6 DIN 934 (AN-H 6) - 2 pcs.

Assembly instructions: CP X-2 H00

To mount the PM x H00 mounting plate on the LG-V6 fixing elements, drill the mounting holes with a Ø6 drill

Note: Mounting plates for HVL EK 00 disconnectors available while stocks last.

Mounting plates for KVL00 disconnectors



Mounting plates for KVL00 disconnectors				
Type	Description	Code nr	Weight (kg)	Packaging (pcs)
PM 1 K00	Mounting plate 1xKVL00 (250)	001340550	0,61	1
PM 1.4 K00	Mounting plate 2xKVL00 (350)	001340551	0,91	1
PM 2 K00	Mounting plate 4xKVL00 (500)	001340552	1,40	1
PM 2.2 K00	Mounting plate 4xKVL00 (550)	001340553	1,51	1
PM 3 K00	Mounting plate 6xKVL00 (750)	001340554	2,15	1

To attach one piece of KVL00 disconnector to the mounting plate, you should buy:

- screw M6x16 DIN 933 (AS-H 6x16) - 4 pcs.
- washer M6 DIN 126 (AW-R 6) - 8 items
- spring washer M6 DIN 127 (AW-S 6) - 4 pcs.
- nut M6 DIN 934 (AN-H 6) - 4 pcs.

Assembly instructions: CP X-2 K00

To mount the PM x K00 mounting plate on the LG-V6 fixing elements, drill the mounting holes with a Ø6 drill

Mounting plates for ED2 / EB2 disconnectors / circuit breakers (125, 160, 250 A) or LBS disconnectors (160, 250 A)

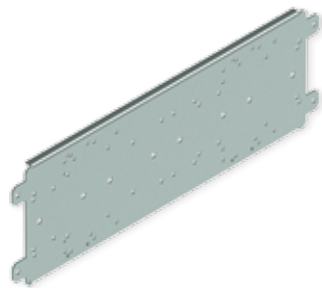

Mounting plates for ED2 / EB2 disconnectors / circuit breakers (125, 160, 250 A) or LBS disconnectors (160, 250 A)				
Type	Description	Code nr	Weight (kg)	Packaging (pcs)
PM 1 E12 L12	Mounting plate 1xEB2/ED2 125,160,250 A 3,4P or 1xLBS (250)	001101584	0,49	1
PM 1.4 E12 L12	Mounting plate 1xEB2/ED2 125,160,250 A 3,4P or 1xLBS (350)	001101585	0,76	1
PM 2 E12 L12	Mounting plate 2xEB2/ED2 125,160,250 A 3,4P or 2xLBS (500)	001101586	1,15	1
PM 2.2 E12 L12	Mounting plate 2xEB2/ED2 125,160,250 A 3,4P or 2xLBS (550)	001101587	1,29	1
PM 3 E12 L12	Mounting plate 3xEB2/ED2 125,160,250 A 3,4P or 3xLBS (750)	001101588	1,82	1
PM 3.8 E12 L12	Mounting plate 3xEB2/ED2 125,160,250 A 3,4P or 3xLBS (950)	001101589	2,35	1

To attach one piece of the EB2 / ED2 circuit breaker / disconnector on the mounting plate, you should purchase:

version 3P

- washer M4 DIN 126 (AW-R 4) - 2 pcs.
- spring washer M4 DIN 127 (AW-S 4) - 2 pcs.
- nut M4 DIN 934 (AN-H 4) W - 2 pcs.

4P version

- washer M4 DIN 126 (AW-R 4) - 4 pcs.
- spring washer M4 DIN 127 (AW-S 4) - 4 pcs.
- nut M4 DIN 934 (AN-H 4) - 4 pcs.

Mounting screws included with the equipment.

Assembly instructions: CP X-2 E12

To attach one piece of LBS 160, 250A 3,4P, you should buy:

- metric Allen screw-M5x50 (AS-SH 5x50) - 4 pcs
- washer M5 DIN 126 (AW-R 5) - 8 pcs.
- spring washer M5 DIN 127 (AW-S 5) - 4 pcs.
- nut M5 DIN 934 (AN-H 5) - 4 pcs.

Assembly instructions: CP X-2 LBS12

To mount the PM x E12 L12 mounting plate on the LG-V6 fixing elements, drill the mounting holes with a Ø6 drill

Mounting plates for EB2 / ED2 circuit breakers / disconnectors (400, 630 A), LBS disconnectors (400, 630 A) or KVL 1,2,3 disconnectors

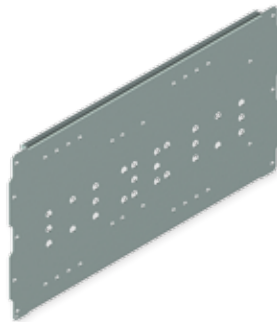

Mounting plates for EB2 / ED2 circuit breakers / disconnectors (400, 630 A), LBS disconnectors (400, 630 A) or KVL 1,2,3 disconnectors				
Type	Description	Code nr	Weight (kg)	Packaging (pcs)
PM 1 ELS46 K1	Mounting plate 1xEB2/ED2/LBS 400, 630A 3P or 1xKVL1 (250)	001340700	1,65	1
PM 1.4 ELS46 K123	Mounting plate 1xEB2/ED2/LBS 400, 630A 3,4P or 1xKVL1,2,3 (350)	001340701	1,89	1
PM 2 ELS46 K123	Mounting plate 2xEB2/ED2/LBS 400, 630A 3P or 1xLBS 400, 630A 4P or 2xKVL1,2 or 1xKVL3 (500)	001340702	2,30	1
PM 2.2 ELS46 K123	Mounting plate 2xEB2/ED2/LBS 400, 630A 3P or 1xLBS 400, 630A 4P or 2xKVL1,2 or 1xKVL3 (550)	001340703	2,47	1
PM 3 ELS46 K123	Mounting plate 3xEB2/ED2/LBS 400, 630A 3P or 1xLBS 400, 630A 4P 3xKVL1,2 or 2xKVL3 (750)	001340704	3,55	1

To attach one piece of the EB2 / ED2 400, 630 A circuit breaker / disconnector:

- washer M6 DIN 126 (AW-R 6) - 4 pcs.
 - spring washer M6 DIN 127 (AW-S 6) - 4 pcs.
 - nut M6 DIN 934 (AN-H 6) - 4 pcs.
- Mounting screws included with the equipment.
Assembly instructions: CP X-2 E46

For mounting one piece of LBS 400, 630 A disconnector it is necessary to buy:

- metric Allen screw - M6x50 (AS-SH 6x50) - 4 pcs
 - washer M6 DIN 126 (AW-R 6) - 8 pcs.
 - spring washer M6 DIN 127 (AW-S 6) - 4 pcs.
 - nut M6 DIN 934 (AN-H 6) - 4 pcs.
- Assembly instructions: CP X-2 LBS46

To attach one piece of KVL1 disconnector it is necessary to buy:

- screw M10x30 (AS-H 10x30) - 4 pcs.
 - washer M10 DIN 126 (AW-R 10) - 4 pcs.
 - spring washer M10 DIN 127 (AW-S 10) - 4 pcs.
 - nut M10 DIN 934 (AN-H 10) - 4 pcs.
- Assembly instructions: CP X-2 K1

To attach one piece of the KVL2,3 disconnector it is necessary to buy:

- screw M10x40 (AS-H 10x40) - 4 pcs.
 - washer M10 DIN 126 (AW-R 10) - 4 pcs.
 - spring washer M10 DIN 127 (AW-S 10) - 4 pcs.
 - nut M10 DIN 934 (AN-H 10) - 4 pcs.
- Assembly instructions: CP X-2 K1

Perforated mounting plates



Perforated mounting plates				
Type	Description	Code nr	Weight (kg)	Packaging (pcs)
PM 1-1 PER-A	Perforaten mounting plate type A (250)	001101620	0,17	1
PM 1-2 PER-A	Perforaten mounting plate type A (250)	001101621	0,48	1
PM 1-3 PER-A	Perforaten mounting plate type A (250)	001101622	0,76	1
PM 1-4 PER-A	Perforaten mounting plate type A (250)	001101623	1,04	1
PM 2-1 PER-A	Perforaten mounting plate type A (500)	001101624	0,38	1
PM 2-2 PER-A	Perforaten mounting plate type A (500)	001101625	0,97	1
PM 2-3 PER-A	Perforaten mounting plate type A (500)	001101626	1,51	1
PM 2-4 PER-A	Perforaten mounting plate type A (500)	001101627	2,05	1
PM 3-1 PER-A	Perforaten mounting plate type A (750)	001101628	0,57	1
PM 3-2 PER-A	Perforaten mounting plate type A (750)	001101629	1,48	1
PM 3-3 PER-A	Perforaten mounting plate type A (750)	001101630	2,29	1
PM 3-4 PER-A	Perforaten mounting plate type A (750)	001101631	3,10	1

9.5 mm x 9.5 mm perforation holes

Assembly instructions: PM X-Y PER-A

To mount the PM X-Y PER-A mounting plate on the LG-V6 fixing elements, drill the mounting holes with a Ø6 drill

Non-perforated mounting plates - universal

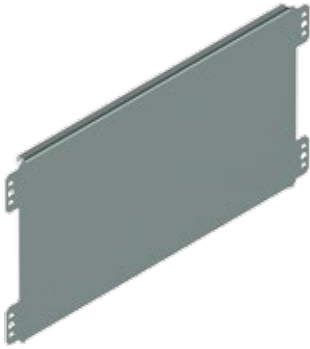

Non-perforated universal mounting plates 240 mm of height				
Type	Description	Code nr	Weight (kg)	Packaging (pcs)
PM-F 1-24	Universal mounting plate (250)	001341000	0,78	1
PM-F 1.4-24	Universal mounting plate (350)	001341001	1,22	1
PM-F 2-24	Universal mounting plate (500)	001341002	1,87	1
PM-F 2.2-24	Universal mounting plate (550)	001341003	2,09	1
PM-F 3-24	Universal mounting plate (750)	001341004	2,99	1

Assembly instructions: PM-F

To mount the PMx-24 mounting plate on the LG-V6 fixing elements, drill the mounting holes with a Ø6 drill

PM-G mounting plates for HXS enclosures



Mounting plates 1800 mm of height				
Type	Description	Code nr	Weight (kg)	Packaging (pcs)
PM-G 1-12	Mounting plate of height 12 (1800) and width 1 (250)	001337963	7,95	1
PM-G 2-12	Mounting plate of height 12 (1800) and width 2 (500)	001337965	15,11	1
PM-G 3-12	Mounting plate of height 12 (1800) and width 3 (750)	001337967	22,26	1
PM-G 4-12	Mounting plate of height 12 (1800) and width 4 (1000)	001337969	36,83	1

Assembly instructions: PM-G

Mounting plates 1950 mm of height				
Type	Description	Code nr	Weight (kg)	Packaging (pcs)
PM-G 1-13	Mounting plate of height 13 (1950) and width 1 (250)	001337970	8,62	1
PM-G 2-13	Mounting plate of height 13 (1950) and width 2 (500)	001337972	16,42	1
PM-G 3-13	Mounting plate of height 13 (1950) and width 3 (750)	001337974	24,52	1
PM-G 4-13	Mounting plate of height 13 (1950) and width 4 (1000)	001337976	39,88	1

Assembly instructions: PM-G

Mounting the plate on the back of the enclosure:

To mount one PM-G on the back of the enclosure, must be ordered:

- side bracket for mounting the mounting plate on the back of the enclosure

UA-B - 3 sets

For fixing the PM-G mounting plate on the back of the enclosure with additional stiffening or using the PM-G plate with a width less than the width of the enclosure, the following should be purchased:

- side bracket for mounting the mounting plate on the back of the enclosure
- UA-B - 2 sets
- stiffening bar for mounting on the rear wall of the enclosure
- BL-UA - 1 set
- mounting bracket for PM-G plates on stiffening bars
- BU-PM - 1 set *

Installation of the depth control panel **::

To mount one PM-G plate with depth adjustment, order:

- side bracket for PM-G plates with depth adjustment

UR-B - 3 sets

- additional CR-A element - 3 sets

For fixing the PM-G mounting plate with depth adjustment ** with additional stiffening or using the PM-G panel with a width less than the width of the enclosure, it is necessary to buy:

- side bracket for PM-G plates with depth adjustment
- UR-B - 2 sets
- stiffening bar with adjustable mounting depth BL-UR - 1 set.
 - mounting bracket for PM-G plates on stiffening bars
- BU-PM - 1 set *
- additional CR-A element - 3 sets

* to provide a center support point for mounting plate, additional BU-PM brackets should be ordered (their number depends on the number of support points of the plate)

** in order to ensure the possibility of adjusting the installation depth of PM-G plates, the enclosure must be equipped with internal set holders with depth control UW-BCR

Vertical supports

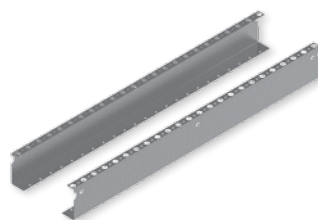

WP-U vertical supports

Type	Description	Code nr	Weight (kg)	Packaging (pcs)
WP-U 2.33	Vertical support 1 position type U (350) (1 set = 2 pcs.)	001101717	0,81	1
WP-U 3	Vertical support 1 position type U (450) (1 set = 2 pcs.)	001101666	1,06	1
WP-U 3.66	Vertical support 1 position type U (550) (1 set = 2 pcs.)	001101667	1,30	1
WP-U 4	Vertical support 1 position type U (600) (1 set = 2 pcs.)	001101668	1,42	1
WP-U 5	Vertical support 1 position type U (750) (1 set = 2 pcs.)	001101669	1,78	1
WP-U 6	Vertical support 1 position type U (900) (1 set = 2 pcs.)	001101670	2,15	1
WP-U 6.33	Vertical support 1 position type U (950) (1 set = 2 pcs.)	001101671	2,27	1
WP-U 7	Vertical support 1 position type U (1050) (1 set = 2 pcs.)	001101672	2,51	1
WP-U 7.66	Vertical support 1 position type U (1150) (1 set = 2 pcs.)	001101673	2,75	1

Assembly instructions: WP-U

Note: WP-U supports do not require additional fixings, TH rails and PM plates are screwed directly to the support.

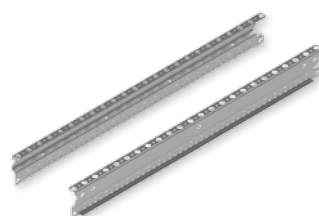

WP-A vertical supports

Type	Description	Code nr	Weight (kg)	Packaging (pcs)
WP-A 2	Vertical support 2 position type A (300) (1 set = left and right)	001338600	0,50	1
WP-A 2.33	Vertical support 2 position type A (350) (1 set = left and right)	001101716	0,68	1
WP-A 3	Vertical support 2 position type A (450) (1 set = left and right)	001101644	0,89	1
WP-A 3.66	Vertical support 2 position type A (550) (1 set = left and right)	001101645	1,09	1
WP-A 4	Vertical support 2 position type A (600) (1 set = left and right)	001101646	1,2	1
WP-A 5	Vertical support 2 position type A (750) (1 set = left and right)	001101647	1,51	1
WP-A 6	Vertical support 2 position type A (900) (1 set = left and right)	001101648	1,82	1
WP-A 6.33	Vertical support 2 position type A (950) (1 set = left and right)	001101649	1,92	1
WP-A 7	Vertical support 2 position type A (1050) (1 set = left and right)	001101650	2,13	1
WP-A 7.66	Vertical support 2 position type A (1150) (1 set = left and right)	001101651	2,34	1
WP-A 8	Vertical support 2 position type A (1200) (1 set = left and right)	001338601	2,42	1
WP-A 9	Vertical support 2 position type A (1350) (1 set = left and right)	001338602	2,73	1
WP-A 10	Vertical support 2 position type A (1500) (1 set = left and right)	001338603	3,03	1
WP-A 11	Vertical support 2 position type A (1650) (1 set = left and right)	001338604	3,33	1
WP-A 12	Vertical support 2 position type A (1800) (1 set = left and right)	001338605	3,65	1
WP-A 13	Vertical support 2 position type A (1950) (1 set = left and right)	001338606	3,85	1

Assembly instructions: WP-A



Reinforced vertical supports WP-T

Type	Description	Code nr	Weight (kg)	Packaging (pcs)
WP-T 7	Reinforced vertical support 2 position type A (1050) (1 set = left and right)	001338758	2,50	1
WP-T 12	Reinforced vertical support 2 position type A (1800) (1 set = left and right)	001338764	4,27	1
WP-T 13	Reinforced vertical support 2 position type A (1950) (1 set = left and right)	001338765	4,55	1

Assembly instructions: WP-T

Note: WP-T supports do not have the possibility to attach CP covers.



WD-K vertical supports

Type	Description	Code nr	Weight (kg)	Packaging (pcs)
WD-K 12	Type K vertical support for cage nuts (1800) (1 pc.)	001338864	2,14	1
WD-K 13	Type K vertical support for cage nuts (1950) (1 pc.)	001338865	2,27	1

Assembly instructions: WD-K

Note: WD-K supports do not have the option of fixing CP covers.

The cage nuts are sold separately (p. 100).

Internal set brackets

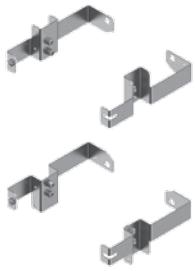

Internal set brackets for GT enclosures 150-250 mm deep (without adjustment)				
Type	Description	Code nr	Weight (kg)	Packaging (pcs)
UW-GT 150	Internal set brackets for GT enclosures 150 mm (1 set = 4 pcs.)	001101705	0,49	1
UW-GT 200	Internal set brackets for GT enclosures 200 mm (1 set = 4 pcs.)	001101706	0,58	1
UW-GT 250	Internal set brackets for GT enclosures 250 mm (1 set = 4 pcs.)	001101707	0,67	1

Includes: 4 x brackets + 6 x washers + 8 x M6x10 Allen screws + 2 x M5x10 screws + 2 x M5 nuts
 Assembly instructions: UW-GT

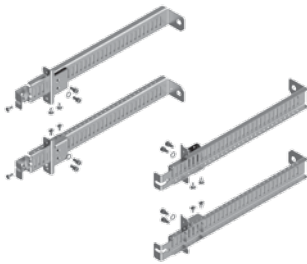

Internal set brackets for GT enclosures 300-400 mm deep (with adjustment)				
Type	Description	Code nr	Weight (kg)	Packaging (pcs)
UW-GT 300	Internal set brackets for GT enclosures 300 mm deep (1 set = 4 pcs.)	001101708	0,82	1
UW-GT 400	Internal set brackets for GT enclosures 400 mm deep (1 set = 4 pcs.)	001101709	1,05	1

Includes: 4 x brackets + 4 x leading elements + 4 x washers + 8 x Allen screws M6x10 + 8 x self-tapping screws PH2 + 2 x screws M5x10 + 2 x nuts M5
 Assembly instructions: UW-GT



2 position internal set bracket for HXS enclosures				
Type	Description	Code nr	Weight (kg)	Packaging (pcs)
UW-BCU 23	2 position internal set bracket for HXS enclosures 300 mm deep (1 set = 2 pcs.)	001338201	0,27	1
UW-BCU 4	2 position internal set bracket for HXS enclosures 400 mm deep (1 set = 2 pcs.)	001338202	0,31	1

Includes: 2 x brackets + 4 x washers + 4 x M6x10 Allen screws + 4 x M6 nuts
 Assembly instructions: UW-BCU



Internal set holder with depth adjustment for HXS enclosures				
Type	Description	Code nr	Weight (kg)	Packaging (pcs)
UW-BCR 3	Internal set holder with depth adjustment for HXS enclosures 300 mm deep (1 set = 2 pcs.)	001338206	0,55	1
UW-BCR 4	Internal set holder with depth adjustment for HXS enclosures 400 mm deep (1 set = 2 pcs.)	001338207	0,68	1

Includes: 2 x holders + 2 x leading elements + 4 x washers + 4 x Allen screws M6x10 + 4 x self-tapping screws PH2 + 4 x M6 nuts
 Assembly instructions: UW-BCR



Additional leading element without fixing possibility of additional covers				
Type	Description	Code nr	Weight (kg)	Packaging (pcs)
CR-A	Additional leading element without fixing possibility of additional covers (1 set = 2 pcs.)	001338215	0,13	1

Assembly instructions: CR-A

Elements for dividing the internal set



Dividing support for HXS enclosures

Type	Description	Code nr	Weight (kg)	Packaging (pcs)
UW-SEP 3	Dividing support for HXS enclosures with a depth of 300 mm	001338302	0,21	1
UW-SEP 4	Dividing support for HXS enclosures with a depth of 400 mm	001338303	0,29	1

Includes: 1 x dividing support + 1 x additional covers connector + 2 x M6 nuts
 Assembly instructions: UW-SEP



Dividing element EP-W (set)

Type	Description	Code nr	Weight (kg)	Packaging (pcs)
EP-W	Dividing element of the enclosure (1 set = 2 pcs.)	001101677	0,11	1

Includes: 2 x dividing elements + 4 x washers + 4 x M6x10 allen screws + 6 x self-tapping screws PH2
 Assembly instructions: EP-W



Dividing element for mounting the WP-T support

Type	Description	Code nr	Weight (kg)	Packaging (pcs)
EP-A	Dividing element for mounting the WP-T support on the UW-SEP element (1 set = 2 pcs.)	001338306	0,14	1

Includes: 2 x dividing elements + 2 x washers + 2 x M8x16 allen screws + 6 x self-tapping screws PH2
 Assembly instructions: EP-A



BL bars for dividing the internal set horizontally

Type	Description	Code nr	Weight (kg)	Packaging (pcs)
BL-WP 2	Dividing bar width 2 (500) division 1: 1	001338900	0,47	1
BL-WP 3	Dividing bar width 2 (500) division 1:1:1 / 2:1 / 1:2	001338901	0,73	1

The set includes:

BL-WP 2: 500 mm wide dividing bar, 8 self-tapping screws, 1 bracket for screwing the internal set, 1 M8 Allen screw with washer.
 BL-WP 3: 750 mm wide dividing bar, 10 self-tapping screws, 2 brackets for screwing the internal set, 2 M8 Allen screws with washer.
 Assembly instructions: BL-WP

Elements for mounting PM-G plates and WD brackets



Side bracket for mounting PM-G plate in HXS series enclosures				
Type	Description	Code nr	Weight (kg)	Packaging (pcs)
UA-B	Side bracket for PM-G plates mounted on the back of the enclosure (1 set = 2 pcs.)	001338102	0,15	1

Assembly instructions: UA-B



Side bracket for mounting WD supports in HXS series enclosures				
Type	Description	Code nr	Weight (kg)	Packaging (pcs)
UA-B-WD	Side bracket for WD supports mounted on the back of the enclosure (1 set = 2 pcs.)	001338103	0,14	1

Assembly instructions: UA-B-WD



Center bracket for mounting PM-G plates and WD support in HXS series enclosures				
Type	Description	Code nr	Weight (kg)	Packaging (pcs)
UA-S	Center bracket for PM-G plates and WD support mounted on the back of the enclosure (1 set = 2 pcs.)	001338104	0,25	1

Assembly instructions: UA-S

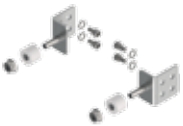

Side bracket for mounting PM-G plates with depth adjustment in HXS series enclosures				
Type	Description	Code nr	Weight (kg)	Packaging (pcs)
UR-B	Side bracket for mounting PM-G plates with depth adjustment (1 set = 2 pcs.)	001338115	0,17	1

Assembly instructions: UR-B

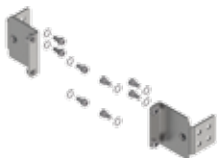

Side bracket for mounting WD supports with depth adjustment in HXS series enclosures				
Type	Description	Code nr	Weight (kg)	Packaging (pcs)
UR-B-WD	Side bracket for mounting WD supports with depth adjustment (1 set = 2 pcs.)	001338116	0,31	1

Assembly instructions: UR-B-WD



Center bracket for mounting PM-G plates and WD supports with depth adjustment in HXS series enclosures				
Type	Description	Code nr	Weight (kg)	Packaging (pcs)
UR-S	Center bracket for PM-G plates and WD supports with depth adjustment (1 set = 2 pcs.)	001338117	0,22	1

Assembly instructions: UR-S

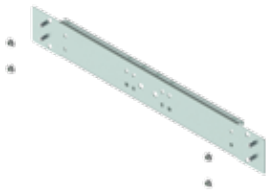
Stiffening bars for PM-G plates and WD supports mounted on the back of the enclosure

Type	Description	Code nr	Weight (kg)	Packaging (pcs)
BL-UA 2	Stiffening bar mounted directly to the enclosure, width 2 (500) (1 set)	001338130	0,78	1
BL-UA 3	Stiffening bar mounted directly to the enclosure, width 3 (750) (1 set)	001338131	1,17	1
BL-UA 4	Stiffening bar mounted directly to the enclosure, width 4 (1000) (1 set)	001338132	1,50	1

Assembly instructions: BL-UA

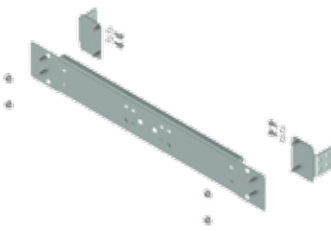
Stiffening bars for PM-G plates and WD supports with adjustable mounting depth

Type	Description	Code nr	Weight (kg)	Packaging (pcs)
BL-UR 2	Stiffening bar with adjustable depth, width 2 (500) (1 set)	001338145	1,02	1
BL-UR 3	Stiffening bar with adjustable depth, width 3 (750) (1 set)	001338146	1,41	1
BL-UR 4	Stiffening bar with adjustable depth, width 4 (1000) (1 set)	001338147	1,73	1

Assembly instructions: BL-UR

Mounting bracket for PM-G plates on BL-UA and BL-UR stiffening bars

Type	Description	Code nr	Weight (kg)	Packaging (pcs)
BU-PM	Bracket for mounting plates, fixed to a stiffening bar (1 set = 2 pcs.)	001338160	0,12	1

Assembly instructions: BU-PM

Bracket for mounting WD support on BL-UA and BL-UR stiffening bars

Type	Description	Code nr	Weight (kg)	Packaging (pcs)
BU-WD	Bracket for WD supports, fixed to a stiffening bars (1 set = 2 pcs.)	001338161	0,18	1

Assembly instructions: BU-WD

Ways of mounting TH rail and PM mounting plates:

In order to mount **TH-S** rails to WP-A vertical supports, it is necessary to purchase one **LG-V SET** with code number **001101683** or to purchase individual elements as listed in the table below. When mounting TH-S rails on the WP-U support, it is need to use 2 self-tapping screws AST 4.8x9.5.



Type	Description	Quantity (pcs.)
LG-V	Fixing element with M5 nut	2
AST 4.8x9.5	Self-tapping screw PH2	4
AW-RE 5	Widened washer	2
AS-C 5x10	Metric screw PH2	2

To mount the **PM ... H00 M**, **PM E12 M**, **PM ... H00**, **PM ... E12 L12** mounting plates for ED2 / EB2 disconnectors and circuit breakers and LA1 and LBS1 disconnectors for WP-A vertical supports, it is necessary to purchase **2 LG-V SET** assembly kits code number **001101683** or purchase of individual items as listed in the table below.



Type	Description	Quantity (pcs.)
LG-V	Fixing element with M5 nut	4
AST 4.8x9.5	Self-tapping screw PH2	8
AW-RE 5	Widened washer	4
AS-C 5x10	Metric screw PH2	4

In order to mount the **PM ... E12 L12** mounting plate for the LA2, LBS2 disconnectors to WP-A vertical supports, it is necessary to buy **2 LG-V5 SET** assembly kits with code number **001101685** or buy individual elements as listed in the table below.



Type	Description	Quantity (pcs.)
LG-V5	Fixing element with M5 nut V5 type	4
AST 4.8x9.5	Self-tapping screw PH2	8
AW-RE 5	Widened washer	4
AS-C 5x10	Metric screw PH2	4

To mount the **PM ... ELS46 K123** mounting plate for the KVL1,2,3 disconnectors and ED2 / EB2 400 - 630 A disconnectors and circuit breakers to the WP-A vertical supports it is necessary to buy **3 LG-V6-B SET** assembly kits with the code number **001341151**

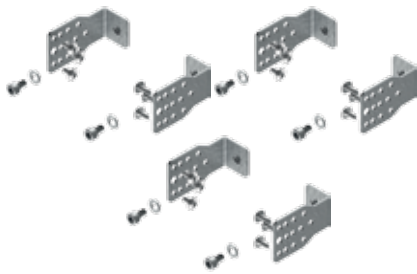

Type	Description	Quantity (pcs.)
LG-V6-B SET	Fixing element with M6 nut type B (1 set = 2 pcs.)	3

To mount the **PM ... ELS46 K123** mounting plate for the LBS46 400 - 630 A disconnectors to the WP-A vertical supports it is necessary to buy **2 LG-V6-D SET** assembly kits with the code number **001341153**

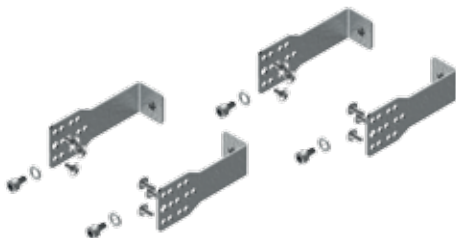

Type	Description	Quantity (pcs.)
LG-V6-D SET	Fixing element with M6 nut type D (1 set = 2 pcs.)	2

Fixing LG-V elements



Fixing element with M5 nut

Type	Description	Code nr	Weight (kg)	Packaging (pcs)
LG-V	Fixing element with M5 nut	001101679	0,03	50



Fixing element with M5 nut type V5

Type	Description	Code nr	Weight (kg)	Packaging (pcs)
LG-V5	Fixing element with M5 nut type V5	001101681	0,04	20



Fixing element with M5 nut (1 set = 2 pcs.)

Type	Description	Code nr	Weight (kg)	Packaging (pcs)
LG-V SET	Fixing element with M5 nut (1 set = 2 pcs.)	001101683	0,07	1

Assembly instructions: LG-V SET



Fixing element with M5 nut type V5 (1 set = 2 pcs.)

Type	Description	Code nr	Weight (kg)	Packaging (pcs)
LG-V5 SET	Fixing element with M5 nut type V5 (1 set = 2 pcs.)	001101685	0,09	1

Assembly instructions: LG-V5 SET



Fastening element with M6 nut type V6-B (1 set = 2 pcs.)

Type	Description	Code nr	Weight (kg)	Packaging (pcs)
LG-V6-B SET	Fastening element with M6 nut type V6-B (1 set = 2 pcs.)	001341151	0,11	1

Assembly instructions: LG-V6-B SET



Fastening element with M6 nut type V6-D (1 set = 2 pcs.)

Type	Description	Code nr	Weight (kg)	Packaging (pcs)
LG-V6-D SET	Fastening element with M6 nut type V6-D (1 set = 2 pcs.)	001341153	0,14	1

Assembly instructions: LG-V6-D SET

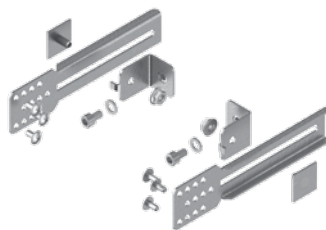

Fixing element with smooth depth adjustment type V6R-B (1 set = 2 pcs.)

Type	Description	Code nr	Weight (kg)	Packaging (pcs)
LG-V6R-B SET	Fixing element with smooth depth adjustment type V6R-B (1 set = 2 pcs.)	001341201	0,25	1

Assembly instructions: LG-V6R-B SET



Fixing element for WP-T supports type T6-A

Type	Description	Code nr	Weight (kg)	Packaging (pcs)
LG-T6-A SET	Fixing element for WP-T supports type T6-A (1 set = 2 pcs.)	001341880	0,22	1

Assembly instructions: LG-T6-A SET

Supports with insulating carriers for busbars



Support with BBS carrier for 1 busbar mounted horizontally on WP-A support

Type	Description	Code nr	Weight (kg)	Packaging (pcs)
LG-B60-H P1	Support with 1-pole BBS carrier	001341650	0,16	1

Assembly instructions: LG-B60-H



Support with BBS carrier for 3 busbars with 60 mm spacing mounted horizontally on WP-A supports

Type	Description	Code nr	Weight (kg)	Packaging (pcs)
LG-B60-H P3	Support with 3-pole BBS carrier	001341651	0,34	1

Assembly instructions: LG-B60-H

At the end of insulating carriers of the busbars use additional protective insulation covers BBS-L 60/3



Support with BBS carrier for up to 4 busbars with 60 mm spacing mounted horizontally on WP-A supports

Type	Description	Code nr	Weight (kg)	Packaging (pcs)
LG-B60-H P4	Support with 4-pole BBS carrier	001341652	0,45	1

Assembly instructions: LG-B60-H

At the end of insulating carriers of the busbars use additional protective insulation L-BBS-60/4

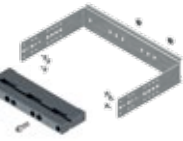

Support with BBS carrier for 3 busbars with 60 mm spacing mounted vertically on WP-A supports - step adjustment of mounting depth

Type	Description	Code nr	Weight (kg)	Packaging (pcs)
LG-B60-V1 P3	Bracket with 3-pole BBS carrier, width 1 (250)	001341700	0,53	1
LG-B60-V2 P3	Bracket with 3-pole BBS carrier, width 2 (500)	001341702	0,75	1

Assembly instructions: LG-B60-V

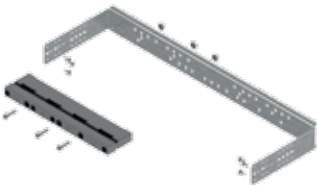

Support with BBS carrier for 4 busbars with 60 mm spacing mounted vertically on WP-A supports - step adjustment of mounting depth

Type	Description	Code nr	Weight (kg)	Packaging (pcs)
LG-B60-V2 P4	Support with 4-pole BBS carrier, width 2 (500)	001341704	0,80	1

Assembly instructions: LG-B60-V

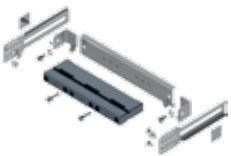

Support with BBS carrier for 3 busbars with 60 mm spacing mounted vertically on WP-A supports - smooth adjustment of the mounting depth

Type	Description	Code nr	Weight (kg)	Packaging (pcs)
LG-B60-V1R P3	Support with 3-pole BBS carrier, width 1 (250)	001341750	0,61	1
LG-B60-V2R P3	Support with 3-pole BBS carrier, width 2 (500)	001341752	0,87	1

Assembly instructions: LG-B60-VxR

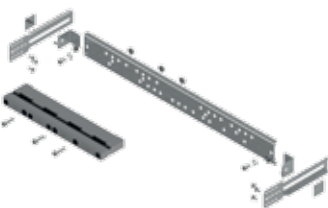

Support with BBS carrier for up to four busbars with 60 mm spacing mounted vertically on WP-A supports - smooth adjustment of the mounting depth

Type	Description	Code nr	Weight (kg)	Packaging (pcs)
LG-B60-V2R P4	Support with 4-pole BBS carrier, width 2 (500)	001341754	0,92	1

Assembly instructions: LG-B60-VxR

Note: When supports with insulating carriers are mounted in a position where busbars or fixing elements are under a distance of less than 15 mm from vertical WP-A / WP-T supports or other metal parts of the construction of the internal set, additional insulating covers should be used as recommended on pages 60-63.

Sets of supports with insulation carriers LG-B60, UD B60, LG-T-B185 and LG-T-INH are sold without busbars.



Support with BBS carrier for the busbar, horizontally mounted directly to the enclosure

Type	Description	Code nr	Weight (kg)	Packaging (pcs)
UD-B60-H P1	Support with BBS 1-pole carrier	001341800	0,48	1

Assembly instructions: UD-B60-H



Support with BBS carrier for up to 3 busbars with 60 mm spacing mounted horizontally directly to the enclosure

Type	Description	Code nr	Weight (kg)	Packaging (pcs)
UD-B60-H P3	Support with 3-pole BBS carrier	001341802	0,55	1

Assembly instructions: UD-B60-H

At the end of insulation carriers of busbars, use additional insulating covers L-BBS-60/3 should be used

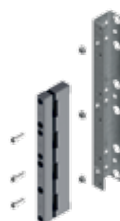

Support with BBS carrier for up to 4 busbars with 60 mm spacing mounted horizontally directly to the enclosure

Type	Description	Code nr	Weight (kg)	Packaging (pcs)
UD-B60-H P4	Support with 4-pole BBS carrier	001341803	0,60	1

Assembly instructions: UD-B60-H

At the end of insulation carriers of busbars, use additional protective insulation-BBS-L 60/4

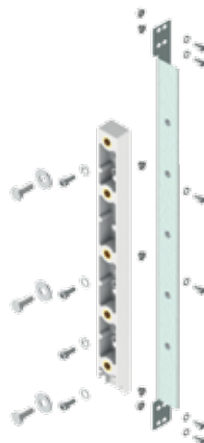

Support with POP 100/185 carrier for up to three busbars with a spacing of 100/185 mm mounted horizontally on WP-T supports

Type	Description	Code nr	Weight (kg)	Packaging (pcs)
LG-T-B185-H P3	Support with POP 100/185 3-pole carrier	001341850	2,92	1

Assembly instructions: LG-T-B185-H P3



Support with INS insulator for one horizontal busbar mounted on WP-T supports

Type	Description	Code nr	Weight (kg)	Packaging (pcs)
LG-T-INH1-A	Support with INS insulator for 1 busbar	001341851	0,13	1

Assembly instructions: LG-T-INH



Support with two INS insulators for one horizontal busbar mounted on WP-T supports

Type	Description	Code nr	Weight (kg)	Packaging (pcs)
LG-T-INH2-A	Support with two INS insulators for 1 busbar	001341852	0,31	1

Assembly instructions: LG-T-INH

Note: When supports with insulating carriers are mounted in a position where busbars or fixing elements are under a distance of less than 15 mm from vertical WP-A / WP-T supports or other metal parts of the construction of the internal set, additional insulating covers should be used as recommended on pages 60-63.

Sets of supports with insulation carriers LG-B60, UD B60, LG-T-B185 and LG-T-INH are sold without busbars.

Accessories for the busbar system



Insulation carriers for busbars with a 60 mm spacing				
Type	Description	Code nr	Weight (kg)	Packaging (pcs)
BBS-60/1	Insulating carrier for 1-pole busbars	001696000	0,036	10
BBS-60/3	Insulation carrier for busbars with a thickness of 5 or 10 mm, 3-pole	001696001	0,114	10
BBS-60/4	Insulation carrier for busbars with a thickness of 5 or 10 mm, 4-pole	001696002	0,152	10

Nośniki szyn BBS-60/x sprzedawane bez śrub montażowych do przykręcenia na wsporniki.



Height adjustment element for 5 mm thick busbars				
Type	Description	Code nr	Weight (kg)	Packaging (pcs)
HS-BBS	Height adjustment element for 5 mm thick busbars	001696005	0,001	100

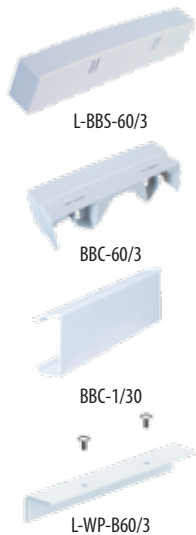

Insulation covers				
Type	Description	Code nr	Weight (kg)	Packaging (pcs)
L-BBS-60/3	Side insulation cover for 3-pole BBS carrier	001696006	0,026	10
L-BBS-60/4	Side insulation cover for 4-pole BBS carrier	001696007	0,041	10
BBC-60/3	Insulating cover 3-pole, for 30 or 20 mm wide and 10 or 5 mm thick	001696009	0,039	50
BBC-60/4	Insulating cover 3-pole, for 30 or 20 mm wide and 10 or 5 mm thick	001696010	0,048	50
BBC-1/20	Insulating cover of a single busbar, for 20 mm wide busbars and thickness 5 or 10 mm, length 1 m	001696011	0,056	20
BBC-1/30	Insulating cover of a single busbar, for 30 mm wide busbars and thickness 5 or 10 mm, length 1 m	001696012	0,076	20
L-WP-B60/3	Insulating 3-pole cover, for mounting on vertical supports, providing insulation from busbars	001342181	0,025	1
L-WP-B60/4	Insulating 4-pole cover, for mounting on vertical supports, providing insulation from busbars	001342182	0,038	1



Insulation carrier for busbars with a spacing of 100 and 185 mm				
Type	Description	Code nr	Weight (kg)	Packaging (pcs)
POP 100/185	Insulation carrier for busbars with a spacing of 100 and 185 mm	001691055	0,446	1



Insulation covers for POP 100/185 carriers				
Type	Description	Code nr	Weight (kg)	Packaging (pcs)
ZP POP 100	Side insulation cover for POP 100/185 carrier, for busbars with 100 mm spacing	001691056	0,226	1
ZP POP 185	Side insulation cover for POP 100/185 carrier, for busbars with 185 mm spacing	001691057	0,226	1
ZP POP-WP	Insulating cover for mounting on vertical supports, providing insulation from the 100/185 mm system busbars	001342180	0,120	1

Membrane cable glands



EH-TKC-36

Membrane cable gland with pins				
Type	Description	Code nr	Weight (kg)	Packaging (pcs)
EH-TKC-36	Cable gland with pins (1 set)	001101711	0,19	1
	4 x 4 mm - 8 mm (IP65)			
	4 x 6 mm - 10 mm (IP65)			
	12 x 7 mm - 12 mm (IP65)			
	14 x 10 mm - 14 mm (IP65)			
	2 x 12 mm - 18 mm (IP65)			
1 x 17 mm - 32 mm (IP65)				

The set includes: 1 x membrane cable gland + 4 x fixing pin
 Assembly instructions: EH-TKC-36



EH-TC-3



EH-TC-17



EH-TC-25



EH-TC-35



EH-TKC-36-S

Membrane cable gland with M8 screws				
Type	Description	Code nr	Weight (kg)	Packaging (pcs)
EH-TC-3-S	Membrane cable gland with M8 screws (1 set)	001338450	0,30	1
	2 x 24 mm - 54 mm (IP65)			
	1 x 30 mm - 59 mm (IP65) 3 x 6 mm - 14 mm (IP55)			
EH-TC-17-S	Membrane cable gland with M8 screws (1 set)	001338452	0,26	1
	9 x 18 mm - 30 mm or 10 mm - 14 mm (IP55)			
	4 x 10 mm - 15 mm (IP55) 4 x 5 mm - 10 mm (IP55)			
EH-TC-25-S	Membrane cable gland with M8 screws (1 set)	001338453	0,30	1
	1 x 20 mm - 26 mm (IP65) or 12 mm - 15 mm (IP55)			
	16 x 8 mm - 14 mm (IP65) or 7 mm - 10 mm (IP55)			
	4 x 14 mm - 20 mm (IP65) or 5 mm - 10 mm (IP55) 4 x 5 mm - 7 mm (IP65)			
EH-TC-35-S	Membrane cable gland with M8 screws (1 set)	001338454	0,29	1
	1 x 17 mm - 32 mm (IP65)			
	2 x 12 mm - 18 mm (IP65)			
	16 x 10 mm - 14 mm (IP65)			
	12 x 7 mm - 12 mm (IP65) 4 x 6 mm - 10 mm (IP65)			
EH-TKC-36-S	Membrane cable gland with M8 screws (1 set)	001338455	0,25	1
	4 x 4 mm - 8 mm (IP65)			
	4 x 6 mm - 10 mm (IP65)			
	12 x 7 mm - 12 mm (IP65)			
	14 x 10 mm - 14 mm (IP65)			
	2 x 12 mm - 18 mm (IP65)			
	1 x 17 mm - 32 mm (IP65)			

Includes: 1 x membrane cable glands + 4 x M8 Allen screw + 4 x M8 nut
 Assembly instructions: EH

Metal cable glands

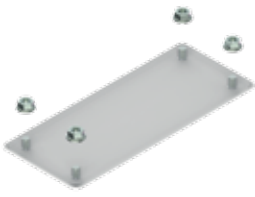

Steel cable gland				
Type	Description	Code nr	Weight (kg)	Packaging (pcs)
EH-ST	Steel cable gland	001101712	0,24	1

The set includes: 1 x steel cable gland + 4 x M8 nut
 Assembly instructions: EH

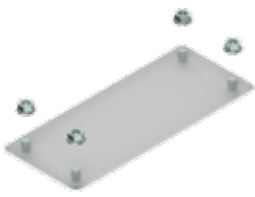

Aluminum cable gland				
Type	Description	Code nr	Weight (kg)	Packaging (pcs)
EH-AL	Aluminum cable gland	001101713	0,16	1

Includes: 1 x aluminum cable gland + 4 x M8 nut
 Assembly instructions: EH

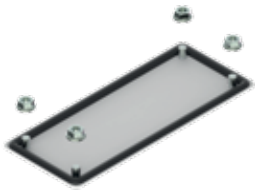

Aluminum cable gland with poured gasket with increased IP protection				
Type	Description	Code nr	Weight (kg)	Packaging (pcs)
EH-AL-IPS	Aluminum cable gland with poured gasket	001338464	0,18	1

The set includes: 1 x aluminum cable gland with poured seal + 4 x M8 nut
 Assembly instructions: EH

EH-AL-IPS

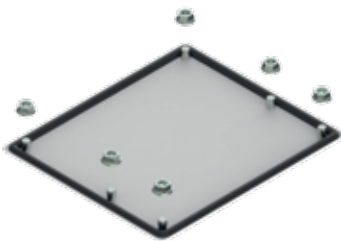

Double aluminum cable gland with a poured gasket with increased IP protection				
Type	Description	Code nr	Weight (kg)	Packaging (pcs)
EH2-AL-IPS	Double aluminum cable gland with a poured gasket	001338467	0,32	1

The set includes: 1 x double aluminum cable gland with poured gasket + 4 x M8 nut
 Assembly instructions: EH

EH2-AL-IPS

Locks, inserts and keys for enclosures

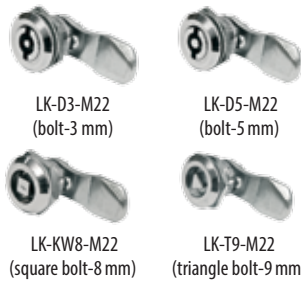

Locks for enclosures (type M22)				
Type	Description	Code nr	Weight (kg)	Packaging (pcs)
LK-D3-M22*	Lock with double bit insert-3 mm	001102167	0,070	1
LK-D5-M22	Lock with double-bit insert-5 mm	001102168	0,070	1
LK-KW8-M22	Lock with square insert	001102169	0,070	1
LK-T9-M22	Lock with a triangle insert	001102170	0,070	1

* - standard equipment for GT enclosures up to 1000 mm



Enclosure locks (type M22) with key code 1333				
Type	Description	Code nr	Weight (kg)	Packaging (pcs)
LK-1333-M22	Lock with patent insert and key code 1333	001102171	0,090	1
LK-B1333-M22	Lock with patent butterfly knob with key code 1333	001102172	0,120	1
LK-CB1333-25-50*	Lock for toothed mechanism with key code 1333	001102180	0,150	1
LK-1333-M22 RAL 7035**	Lock with patent insert and key code 1333 RAL7035	001101718	0,070	1

* - lock for GT enclosures from a height of 1000 mm with a 3-point locking system

** - standard equipment of 4XN / 4XP enclosures (there are two locks in each enclosure)



Inserts for locks with a lever mechanism				
Type	Description	Code nr	Weight (kg)	Packaging (pcs)
LK-WRS-D3	D3 insert for the lock with lever mechanism	001343100	0,074	1
LK-WRS-D5	D5 insert for the lock with a lever mechanism	001343101	0,075	1
LK-WRS-1333	Patent insert for lock with lever mechanism with key code 1333	001343102	0,092	1
LK-WRS-KW8	KW8 insert for the lock with lever mechanism	001343103	0,071	1
LK-WRS-T9	T9 insert for the lock with lever mechanism	001343104	0,069	1



Keys for locks and inserts				
Type	Description	Code nr	Weight (kg)	Packaging (pcs)
KEY-D5-M	D5 key	001102173	0,040	1
KEY-T9-M	Triangle T9 key	001102174	0,040	1
KEY-KW8-M	Square 8 mm key	001102175	0,040	1
KEY-UNI-M	Universal key (for D5, T9, KW8, N locks)	001102176	0,070	1
KEY-1333	Patent key 1333	001343000	0,015	1

Other enclosure accessories



Holder for hanging 4XN160 enclosures				
Type	Description	Code nr	Weight (kg)	Packaging (pcs)
UCH-2	Holder for hanging the enclosure (1 set = 2 pcs.)	001101715	0,060	1



Holder for hanging GT enclosures and fixing HXS enclosures to the walls				
Type	Description	Code nr	Weight (kg)	Packaging (pcs)
U400	Holders for attaching to or on the wall - set (1 set = 4 pcs.)	001102166	0,370	1



Gasket				
Type	Description	Code nr	Weight (kg)	Packaging (pcs)
SEAL-G9	Gasket for gluing -10 meters (1 set = 10 m)	001101608	0,090	1



A set for connecting enclosures in a row				
Type	Description	Code nr	Weight (kg)	Packaging (pcs)
ZL-GXA-SEAL	Kit for connecting the enclosures (1 set)	001342651	0,360	1



RAL7035 repair paint				
Type	Description	Code nr	Weight (kg)	Packaging (pcs)
FA-RAL7035	RAL7035 repair paint (200 ml)	001101710	0,230	1



Pliers for cutting weaknesses in CP covers				
Type	Description	Code nr	Weight (kg)	Packaging (pcs)
CP-PLIER	Pliers for CP covers	001101714	0,070	1



The door grounding cable				
Type	Description	Code nr	Weight (kg)	Packaging (pcs)
LPE-6	6 mm ² door grounding cable, length 200 mm	001102177	0,020	1
LPE-16 M6/M8	6 mm ² earthing cable for internal set in standing enclosures, length 300 mm	001342850	0,025	1



Pocket for documentation				
Type	Description	Code nr	Weight (kg)	Packaging (pcs)
K-A4	Pocket for A4 documentation	001102178	0,160	1
K-A4-PT	Foil pocket for A4 documentation	001343200	0,028	1



Clasp for CP covers				
Type	Description	Code nr	Weight (kg)	Packaging (pcs)
ZAP-CP	Clasp for CP covers	001338950	0,020	10

Screws, nuts and washers



Self tapping screws PH2

Type	Description	Code nr	Weight (kg)	Packaging (pcs)
AST 4.8x9.5 SET	Self-tapping screw PH2 (1 set = 200 pcs.)	001101686	0,400	1



Metric Allen screw

Type	Description	Code nr	Weight (kg)	Packaging (pcs)
AS-SH 5x50 SET	Metric Allen screw M5 (1 set = 10 pcs.)	001343408	0,087	1
AS-SH 6x10 SET	Metric Allen screw M6 (1 set = 10 pcs.)	001343409	0,045	1
AS-SH 6x20 SET	Metric Allen screw M6 (1 set = 10 pcs.)	001343412	0,069	1
AS-SH 6x35 SET	Metric Allen screw M6 (1 set = 10 pcs.)	001343415	0,095	1
AS-SH 6x50 SET	Metric Allen screw M6 (1 set = 10 pcs.)	001343418	0,130	1
AS-SH 8x16 SET	Metric Allen screw M8 (1 set = 10 pcs.)	001343421	0,120	1



Metric screw - PH2 DIN7985

Type	Description	Code nr	Weight (kg)	Packaging (pcs)
AS-C 4x16 SET	Metric screw - PH2 DIN7985 (1 set = 10 pcs.)	001101687	0,020	1
AS-C 4x20 SET	Metric screw - PH2 DIN7985 (1 set = 10 pcs.)	001101688	0,030	1



Śruba metryczna - krzyżak PH2 DIN7985

Type	Description	Code nr	Weight (kg)	Packaging (pcs)
AS-C 5x10 SET	Metric screw - PH2 DIN7985 (1 set = 100 pcs.)	001101689	0,300	1



Metric screw M6 - hexagon DIN933

Type	Description	Code nr	Weight (kg)	Packaging (pcs)
AS-H 6x16 SET	Metric screw M6 - hexagon DIN933 (1 set = 10 pcs.)	001101690	0,065	1
AS-H 10x30 SET	Metric screw M10 - hexagon DIN933 (1 set = 10 pcs.)	001343487	0,270	1
AS-H 10x40 SET	Metric screw M10 - hexagon DIN933 (1 set = 10 pcs.)	001343489	0,320	1



Extended washer DIN9021

Type	Description	Code nr	Weight (kg)	Packaging (pcs)
AW-RE 5 SET	Washer d=5,3 D=15 widened DIN9021 (1 set = 100 pcs.)	001101692	0,150	1



Round washers DIN126

Type	Description	Code nr	Weight (kg)	Packaging (pcs)
AW-R 4 SET	Round washer d=4,3 D=10 DIN126 (1 set = 10 pcs.)	001101693	0,003	1
AW-R 5 SET	Round washer d=5,5 D=10 DIN126 (1 set = 10 pcs.)	001343901	0,004	1
AW-R 6 SET	Round washer d=6,6 D=12 DIN126 (1 set = 10 pcs.)	001101694	0,008	1
AW-R 10 SET	Round washer d=11 D=20 DIN126 (1 set = 10 pcs.)	001343904	0,035	1



Spring washers DIN127

Type	Description	Code nr	Weight (kg)	Packaging (pcs)
AW-S 4 SET	Spring washer d=4,1 D=6,88 DIN127 (1 set = 10 pcs.)	001101696	0,002	1
AW-S 5 SET	Spring washer d=5,1 D=9,3 DIN127 (1 set = 10 pcs.)	001343913	0,003	1
AW-S 6 SET	Spring washer d=6,1 D=9,78 DIN127 (1 set = 10 pcs.)	001101698	0,007	1
AW-S 10 SET	Spring washer d=10,2 D=18,1 DIN127 (1 set = 10 pcs.)	001343916	0,040	1



Nuts DIN934

Type	Description	Code nr	Weight (kg)	Packaging (pcs)
AN-H 4 SET	Nut M4 DIN934 (1 set = 10 pcs.)	001101700	0,010	1
AN-H 5 SET	Nut M5 DIN934 (1 set = 10 pcs.)	001343713	0,018	1
AN-H 6 SET	Nut M6 DIN934 (1 set = 10 pcs.)	001101702	0,020	1
AN-H 10 SET	Nut M10 DIN934 (1 set = 10 pcs.)	001343716	0,100	1



Nuts with a collar

Type	Description	Code nr	Weight (kg)	Packaging (pcs)
AN-FSH 6 SET	M6 nuts with a collar (1 set = 10 pcs.)	001343708	0,048	1
AN-FSH 8 SET	M8 nuts with a collar (1 set = 10 pcs.)	001343709	0,072	1



Cage nuts for universal plates with perforations PM x-x PER-A

Type	Description	Code nr	Weight (kg)	Packaging (pcs)
AN-KFH 9.5x9.5 M6	The M6 cage nut is inserted from the back to the 9.5 x 9.5 mm hole	001343729	0,004	10

AN-KFH cage nuts for 0.7 - 1.6 mm thick sheet metal



Cage nuts for vertical WD-K supports

Type	Description	Code nr	Weight (kg)	Packaging (pcs)
AN-KFH 8x13 M6	M6 cage nut inserted from the front to the 8 x 13 mm hole	001343730	0,003	10
AN-KFH 10.5x16.5 M8	The M8 cage nut is inserted from the front to the 10.5 x 16.5 mm hole	001343731	0,008	10

AN-KFH cage nuts for 2 - 2,1 mm thick sheet metal

Dimensional drawings

UW-SEP dividing elements and internal set brackets with UW-BCR mounting depth adjustment

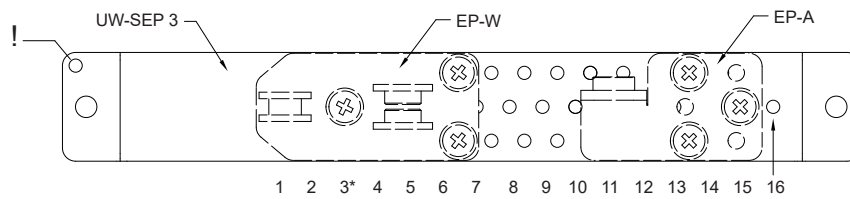
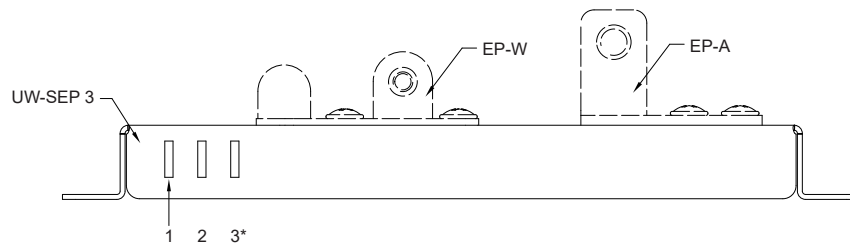
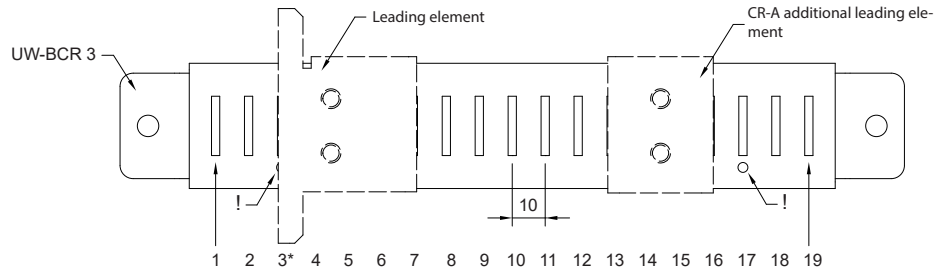

* basic mounting position of the internal set for UW-BCR 3, the distance between the covers and the enclosure door is 80 mm
! - position marker

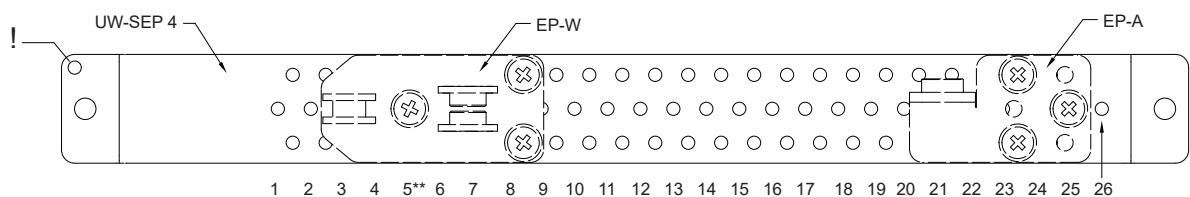
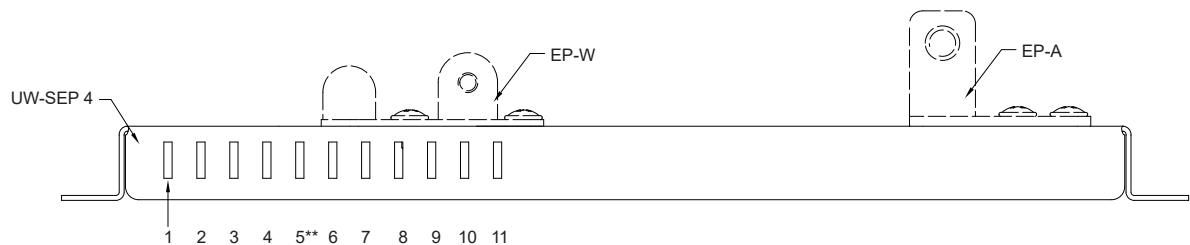
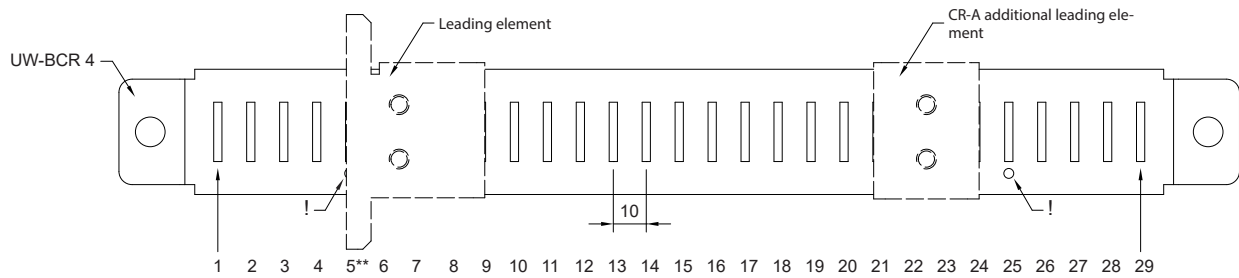

* basic mounting position of the internal set for UW-BCR 4, the distance between the covers and the enclosure door is 100 mm
! - position marker

Fixing elements LG-V and LG-T

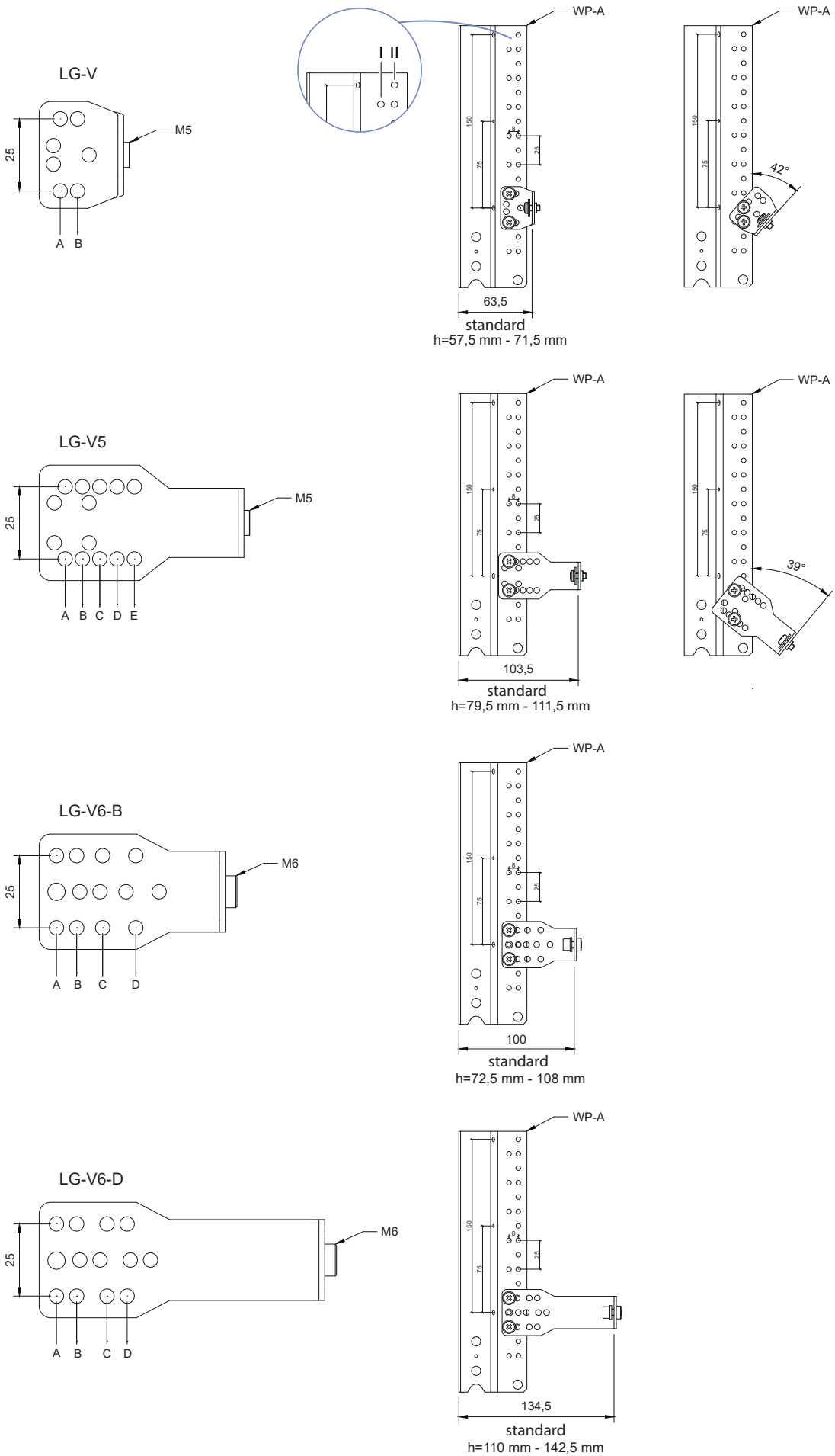

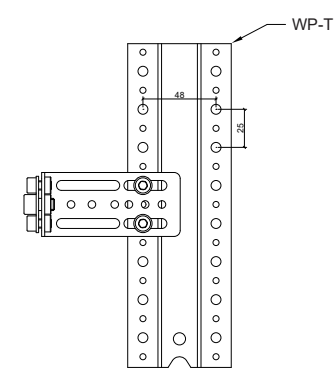
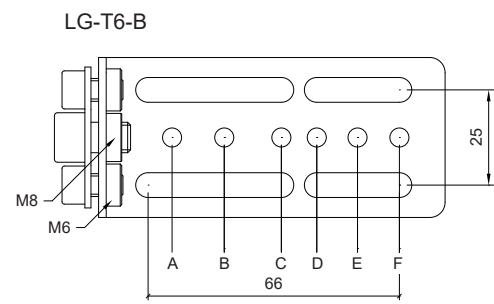
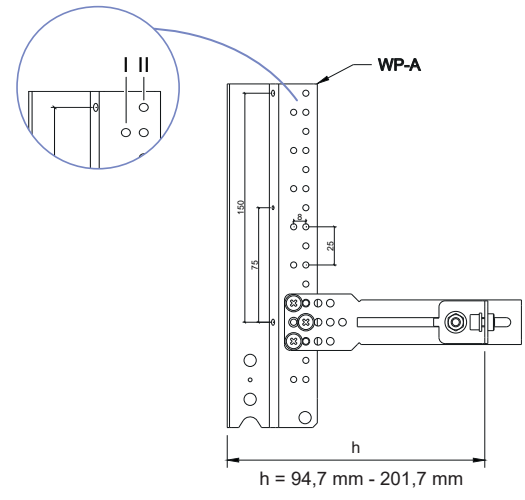
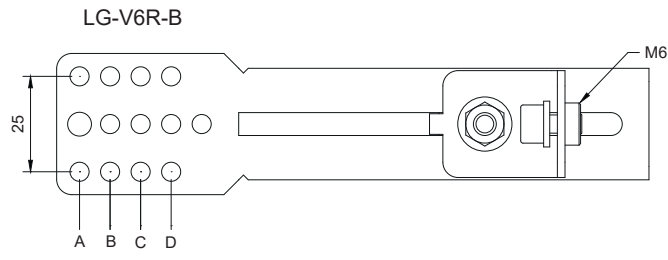

Holders for attaching enclosures to walls

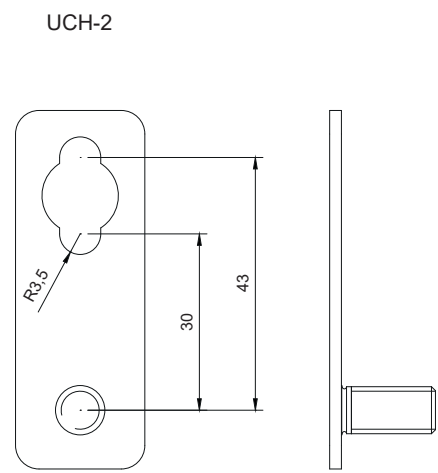
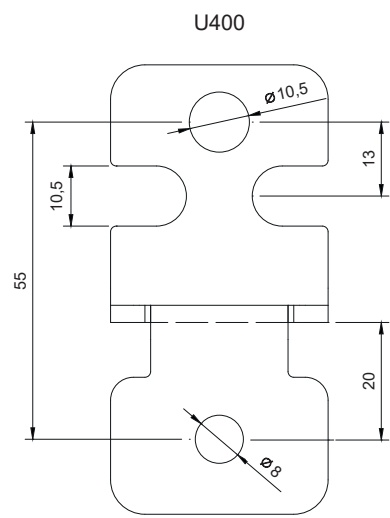

Examples of enclosures configurations with internal sets

Example 1. 4XP160 2-4 flush enclosure with economical internal set for modular equipment

4XP160 flush mounted enclosure with IP42 protection (it is possible to increase it to IP44 by appropriate gluing SEAL-G9 gasket), width 610 mm, height 710 mm, depth 160 mm. The enclosure is adapted for the assembly of devices with a total number of 96 modules. The WP-U bracket used is an economical version without the possibility to adjust the TH-S mounting rails at depth and without the possibility of dividing the enclosure vertically. Please note that AST 4.8x9.5 self-tapping screws needed for fixing TH-S rails and PM mounting plates are sold in sets of 200 pieces. For the following order 8 pieces of self-tapping screws are needed.

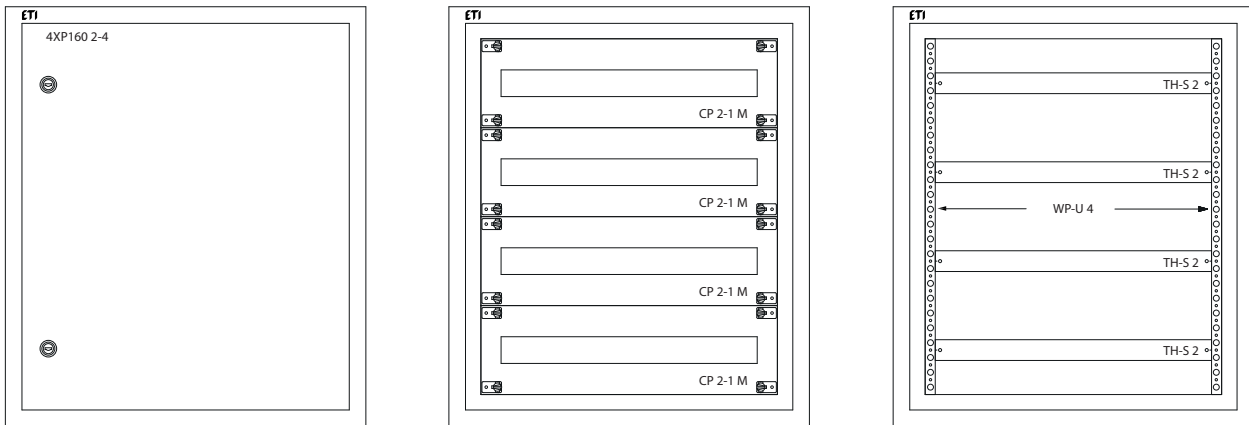

List of 4XP160 2-4 flush-mounted enclosure with economical internal set for modular equipment

No.	Type	Product name	Code no.	Quantity to order
1	4XP160 2-4	Empty flush mounted enclosure, IP42, class I RAL7035 (610x710x160)	001101411	1
2	WP-U 4	Vertical bracket 1 position U type (600) (1 set = 2 pcs.)	001101668	1
3	CP 2-1 M	Modular cover 24 mod. (500x150)	001101453	4
4	TH-S 2	Steel mounting rail 35/15 1.5 465 mm (500)	002911042	4
5	AST 4.8x9.5 SET	Self-tapping screw PH2 (1 set = 200 pcs.)	001101686	1

Example 2. Wall mounted enclosure 4XN160 2-6 with internal set for modular equipment

4XN160 wall mounted enclosure with IP41 protection (it is possible to increase it to IP44 by appropriate gluing SEAL-G9 gasket), width 550 mm, height 950 mm, depth 160 mm. The enclosure is adapted for the assembly of devices with a total number of 144 modules. Thanks to the vertical WP-A support, TH-S rails can be adjusted to a depth.

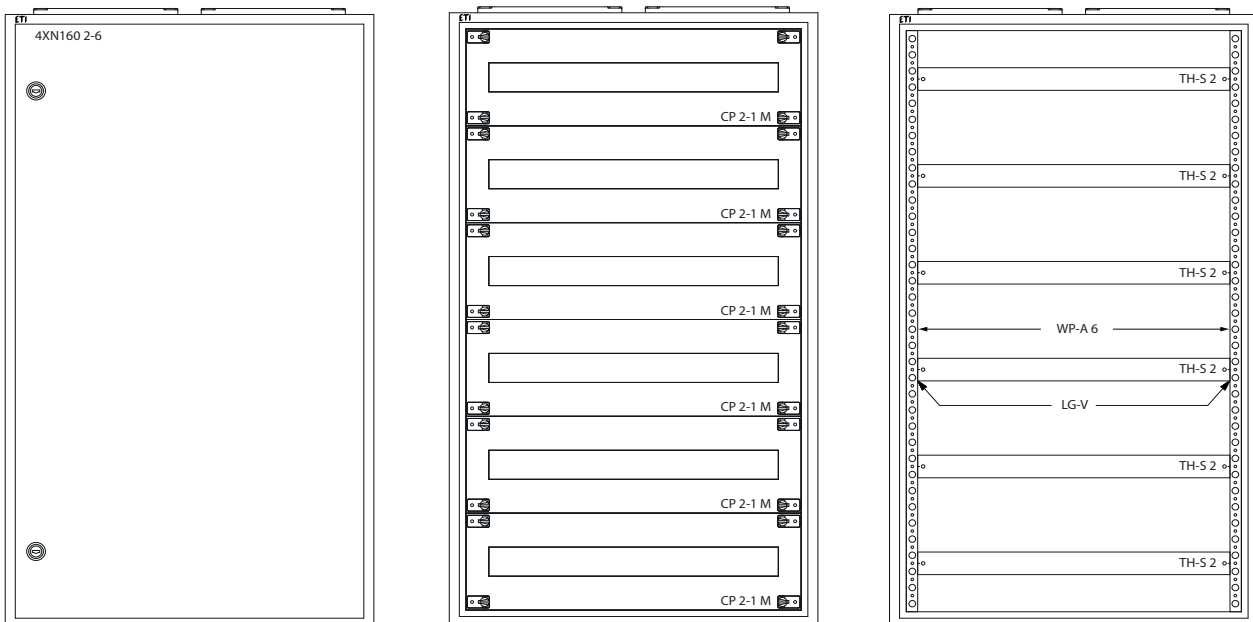

List of wall mounted enclosure 4XN160 2-6 with internal set for modular equipment

No.	Type	Product name	Code no.	Quantity to order
1	4XN160 2-6	Empty wall mounted enclosure, IP41, class I RAL7035 (550x950x160)	001101403	1
2	WP-A 6	Vertical support 3 position type A (900) (1 set = left and right)	001101648	1
3	CP 2-1 M	Modular cover 24 mod. (500x150)	001101453	6
4	TH-S 2	Steel munting rail 35/15 1.5 465 mm (500)	002911042	6
5	LG-V SET	Fixing element (1 set = 2 pcs.)	001101683	6

Example 3. Wall mounted enclosure 4XN160 3-7 with internal set for modular equipment, MCCB's / disconnectors EB / ED 125, 160, 250 A

4XN160 wall mounted enclosure with IP41 protection (it is possible to increase it to IP44 by appropriate gluing SEAL-G9 gasket), width 800 mm, height 1100 mm, depth 160 mm. The enclosure is suitable for mounting equipment with a total number of 252 modules. In the following configuration, the enclosure is suitable for mounting 156 modules, 1 disconnector / MCCB ED / EB 125, 160, 250 A, perforated mounting plate for teletechnics. The enclosure is divided vertically into a field with a width of 1 (250 mm) and 2 (500 mm). Thanks to the use of the WP-A, vertical support it is possible to adjust the rails to a depth. The enclosure is mounted on the wall using UCH-2 brackets.

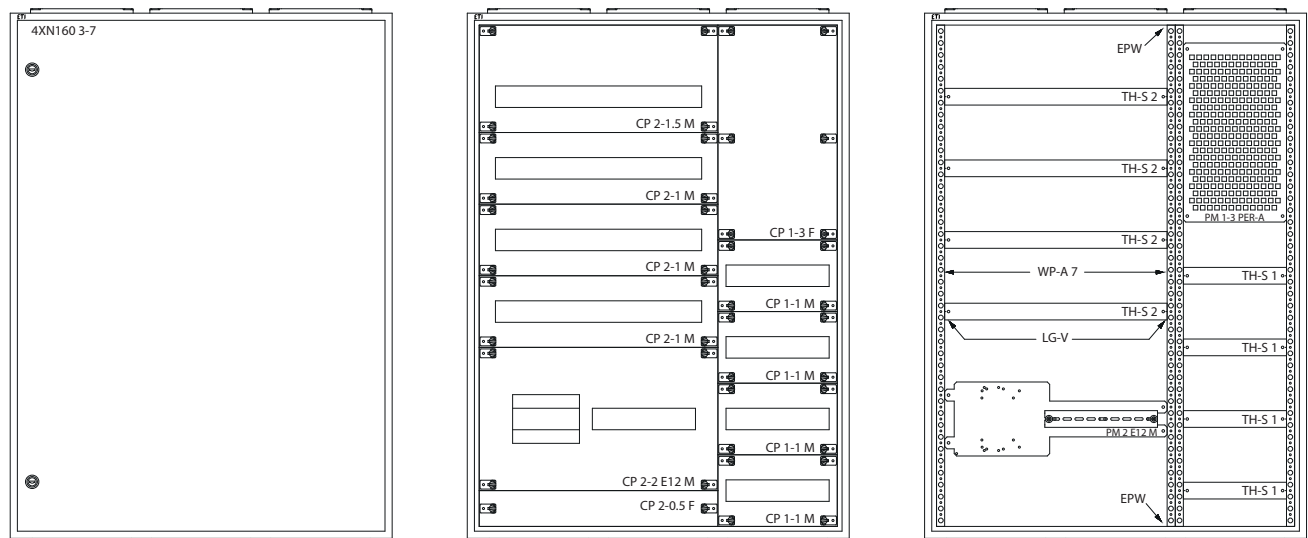

List of wall mounted enclosure 4XN160 3-7 with internal set for modular equipment, MCCB's / disconnectors EB / ED 125, 160, 250 A

No.	Type	Product name	Code no.	Quantity to order
1	4XN160 3-7	Empty wall mounted enclosure, IP41, class I RAL7035 (800x1100x160)	001101409	1
2	CP 1-1 M	Modular cover 12 mod. (250x150)	001101451	4
3	WP-A 7	Vertical support 3 position type A (1050) (1 set = left and right)	001101650	2
4	CP 1-3 F	Full cover (250x450)	001101443	1
5	CP 2-0.5 F	Full cover (500x75)	001101426	1
6	CP 2-1 M	Modular cover 24 mod. (500x150)	001101453	3
7	CP 2-1.5 M	Modular cover 24 mod. (500x225)	001101459	1
8	CP 2-2 E12 M	1xEB2 / ED2 cover 125.160.250 A 3.4P and 12 mod. (500x300)	001101483	1
9	EPW	Dividing element of the enclosure (1 set = 2 pcs.)	001101677	1
10	PM 1-3 PER-A	Perforated mounting plate type A (250)	001101622	1
11	PM 2 E12 M	1xEB2 / ED2 mounting plate with TH35 rail for 12 mod. (500)	001101572	1
12	TH-S 1	Steel mounting rail 35/15 1.5 215 mm (250)	002911040	4
13	TH-S 2	Steel mounting rail 35/15 1.5 465 mm (500)	002911042	4
14	UCH-2	Holder for hanging the enclosure (1 set = 2 pcs)	001101715	1
15	LG-V SET	Fixing element (1 set = 2 pcs)	001101683	12

Example 4. GT 100-60-25 wall mounted enclosure with a internal set

GT housing with protection class IP66, height 1000 mm, width 600 mm, depth 250 mm with mounting plate and internal set for modular equipment and disconnectors, MCCB's, fuse-links disconnectors. The following set allows installing electrical equipment with a total number of 66 modules and 4 NH00 fuse-links disconnectors, 1 ED / EB disconnector / MCCB 125, 160, 250 A. It is also possible to install the devices directly on the GT enclosure mounting plate under the internal set (two mounting levels).

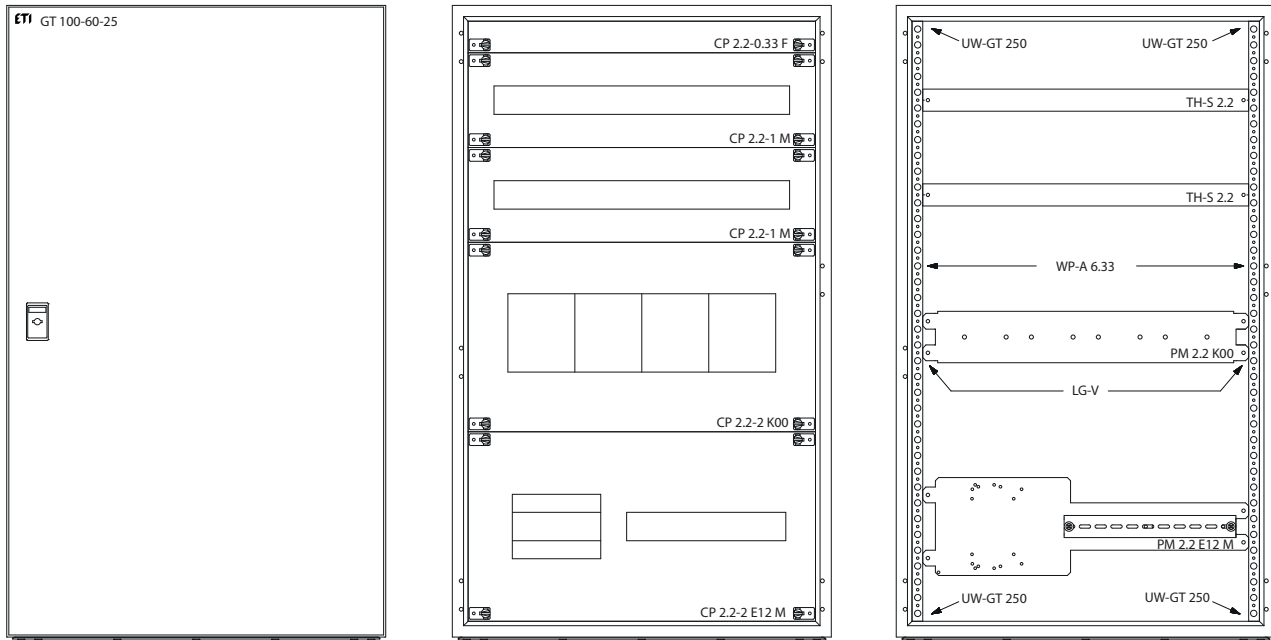

A list of a GT 100-60-25 wall mounted enclosure with a internal set

No.	Type	Product name	Code no.	Quantity to order
1	GT 100-60-25	IP66 hermetic enclosure	001102142	1
2	UW-GT 250	Internal set bracket for the GT enclosure with a depth of 250 mm (1 set = 4 pcs.)	001101707	1
3	WP-A 6.33	Vertical support 3 position type A (950) (1 set = left and right)	001101649	1
4	CP 2.2-1 M	Modular cover 26 mod. (550x150)	001101454	2
5	CP 2.2-2 K00	Cover 4xK00 (550x300)	001339503	1
6	CP 2.2-2 E12 M	1xEB2 / ED2 125,160,250 A 3,4P cover and 14 mod. (550x300)	001101484	1
7	CP 2.2-0.33 F	Full cover (550x50)	001101422	1
8	TH-S 2.2	Steel mounting rail 35/15 1.5 515 mm (550)	002911043	2
9	PM 2.2 K00	Mounting plate 4xK00 (550)	001340553	1
10	PM 2.2 E12 L12	Mounting plate 2xEB2 / ED2 125,160,250 A 3,4P or 2xLA1,2 (550)	001101587	1
11	LG-V SET	Fixing element (1 set = 2 pcs)	001101683	6

REMEMBER!

- In order to mount the internal set with the electrical equipment in GT enclosures, additional UW-GT brackets should be purchased.
- Depth adjustment of the internal set is possible in GT enclosures with a depth of 300 and 400 mm.
- When replacing the lock with a different one, select the type and number of locks depending on the type of GT enclosure.

Example 5. HXS300 3-12 standing enclosure with mounting plate

HXS300 3-12 PH1 standing enclosure with IP65 protection, height 1950 mm (including 100 mm plinth), width 800 mm and depth 300 mm. In the following configuration, the enclosure is equipped with a mounting plate with a width of 3 (750 mm) and a height of 12 (1800 mm) on UA-B brackets (mounting plate on the back of the enclosure without the possibility of adjusting the depth).

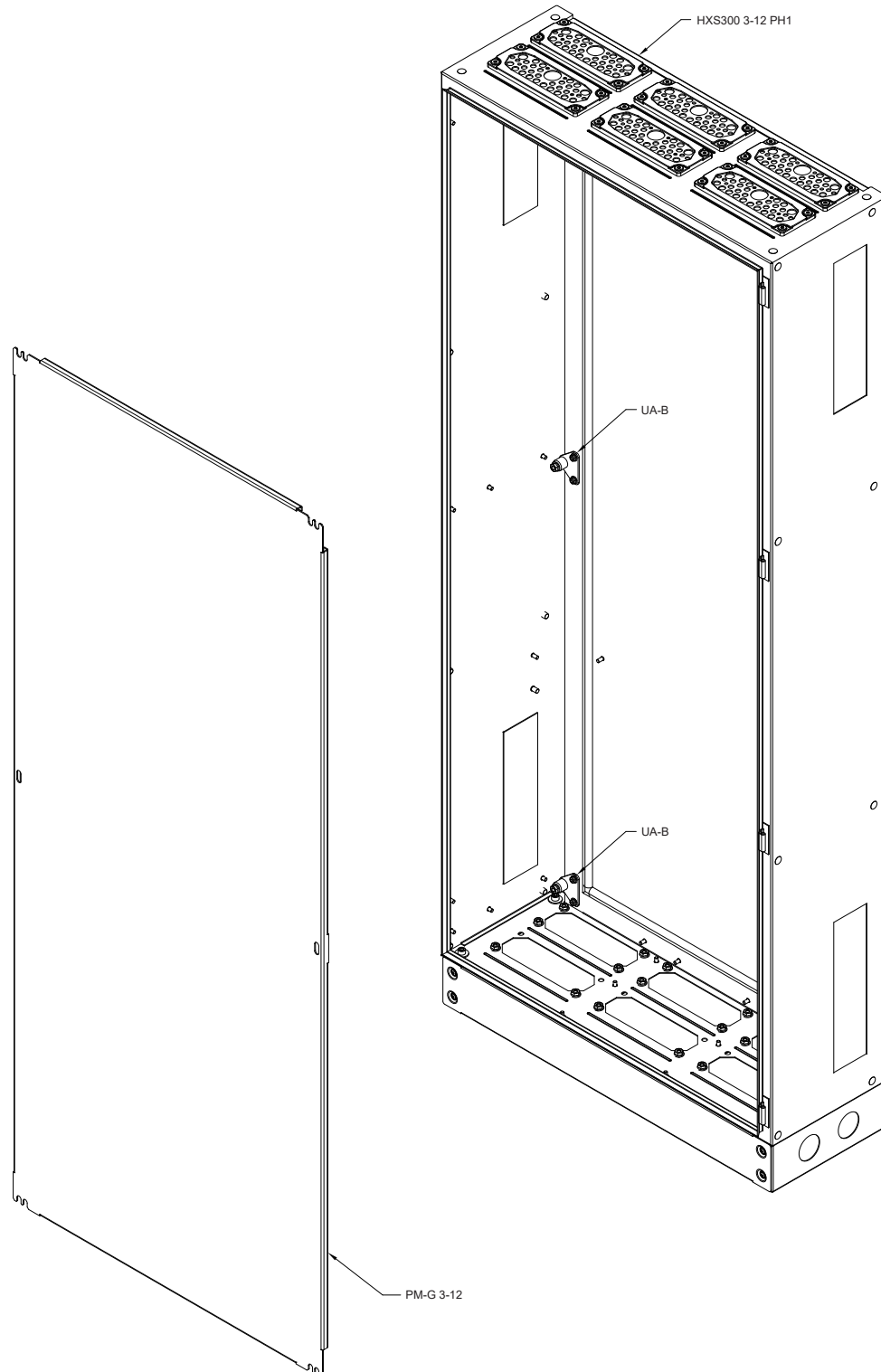

View of the enclosure from Example 5

List of elements for HXS300 3-12 PH1 enclosure from example 5

No.	Type	Product name	Code no.	Quantity to order
1	HXS300 3-12 PH1	Empty standing enclosure, IP65, class I RAL7035 (800x1850x300) with 100 mm plinth	001325103	1
2	UA-B	Side handle for PM-G plates mounted on the back of the housing (1 set = 2 pcs)	001338102	3
3	PM-G 3-12	Mounting plate with a height of 12 (1800) and a width of 3 (750)	001337967	1

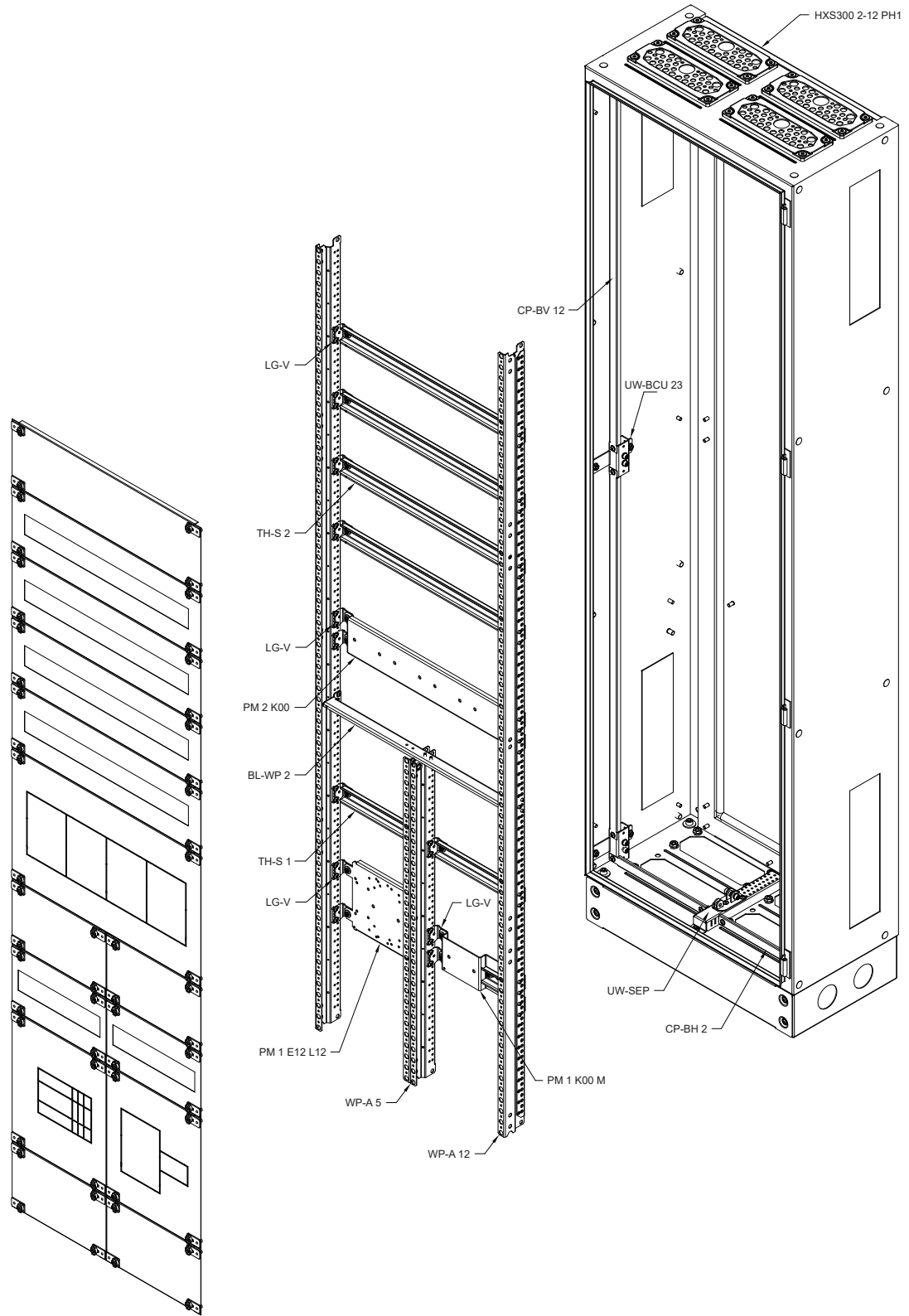

View of the decomposed enclosure from example 6

List of elements for enclosure HXS300 2-12 PH1 from example 6

No.	Type	Product name	Code no.	Quantity to order
1	HXS300 2-12 PH1	Empty standing enclosure, IP65, class I RAL7035 (550x1850x300) with 100 mm plinth	001325102	1
2	UW-BCU 23	Internal set bracket 2 position for HXS enclosures with a depth of 300 mm (1 set = 2 pcs.)	001338201	3
3	UW-SEP 3	Dividing support for HXS enclosures with a depth of 300 mm	001338302	1
4	EP-W	Dividing element of the enclosure (1 set = 2 pcs.)	001101677	1
5	WP-A 5	Vertical support 3 position type A (750) (1 set = left and right)	001101647	1
6	WP-A 12	Vertical support, 2-position, type A (1800) (1 set = left and right)	001338605	1
7	BL-WP 2	Split bar width 2 (500) split 1: 1	001338900	1
8	LG-V SET	Fixing element (1 set = 2 pcs)	001101683	12
9	TH-S 1	Steel mounting rail 35/15 1.5 215 mm (250)	002911040	2
10	TH-S 2	Steel mounting rail 35/15 1.5 465 mm (500)	002911042	4
11	PM 1 E12 L12	Mounting plate 1xE12 / ED2 125,160,250A 3,4P or 1xLA1,2 (250)	001101584	1
12	PM 1 K00 M	1xKVL00 cover and 4 mod. (250x300)	001340500	1
13	PM 2 K00	Mounting plate 4xKVL00 (500)	001340552	1
14	CP 2-1 F	Full cover (500x150)	001101431	1
15	CP 2-1 M	Modular cover 24 mod. (500x150)	001101453	4
16	CP 2-2 K00	Cover 4xKVL00 (500x300)	001339502	1
17	CP 1-1 F	Full cover (250x150)	001101429	4
18	CP 1-1 M	Modular cover 12 mod. (250x150)	001101451	2
19	CP 1-2 E12	Cover 1xE12 / ED2 125.160.250A 3.4P (250x300)	001101514	1
20	CP 1-2 K00 M	Cover for 1xKVL00 and 4 mod. (250x300)	001339450	1
21	CP-BV 12	Side additional covers for HXS enclosures, height 12 (1800) (1 set = 4 pcs.)	001340164	1
22	CP-BH 2	Horizontal upper and lower additional covers, divided, for HXS enclosures, width 2 (500) (1 set)	001340200	1

REMEMBER!

- In order to install the internal set with the electrical equipment in the HXS enclosures, you should buy the UW-BCU or UW-BCR brackets.
- With the simultaneous division of the (width 3 - 750 mm) internal set vertically and horizontally (BL-WP 3), make sure that the bottom section is divided into 2 + 1, 1 + 2 or 1 + 1 + 1. The use of BL WP 3 divider bar without providing at least one division in the bottom section is not allowed.

Example 7. HXS300 3-12 PH1 standing enclosure with mounting internal set for modular equipment, MCCB / disconnecter EB2 / ED2 125, 160, 250 A, KVL NH00 fuse-links disconnectors, with busbar set and with PM-G 1-12 mounting plate mounted on brackets without depth adjustment

HXS300 3-12 PH1 standing enclosure with IP65 protection, 1950 mm (including 100 mm plinth), width 800 mm and depth 300 mm. In the following configuration, the enclosure is suitable for mounting 69 modular devices (18 mm), 3 KVL NH00 disconnectors, 1 MCCB / disconnecter ED2 / EB2 125, 160, 250 A. In addition, the enclosure is equipped with a mounting plate with a width of 1 (250 mm) and height of 12 (1800 mm). The enclosure is divided into two sections, the first section with a width of 1 (250 mm) with the mounting plate on the supports without the possibility of depth adjustment and the second section for the internal set for the electrical equipment. The internal set with the equipment was additionally divided horizontally into fields with a height of 3, 5 and 4. The lower and upper part was divided vertically into 2 fields with a width of 1 (250 mm). Thanks to the use of the WP-A support, it is possible to adjust the TH S rails to a depth. The UW-BCR 3 mounting element enables step adjustment of the insertion depth of the entire internal set (60 mm - 240 mm from covers to the enclosure door). In addition, the internal set is equipped with supports for insulating busbar carriers with a 60 mm spacing mounted on WP-A vertical supports.

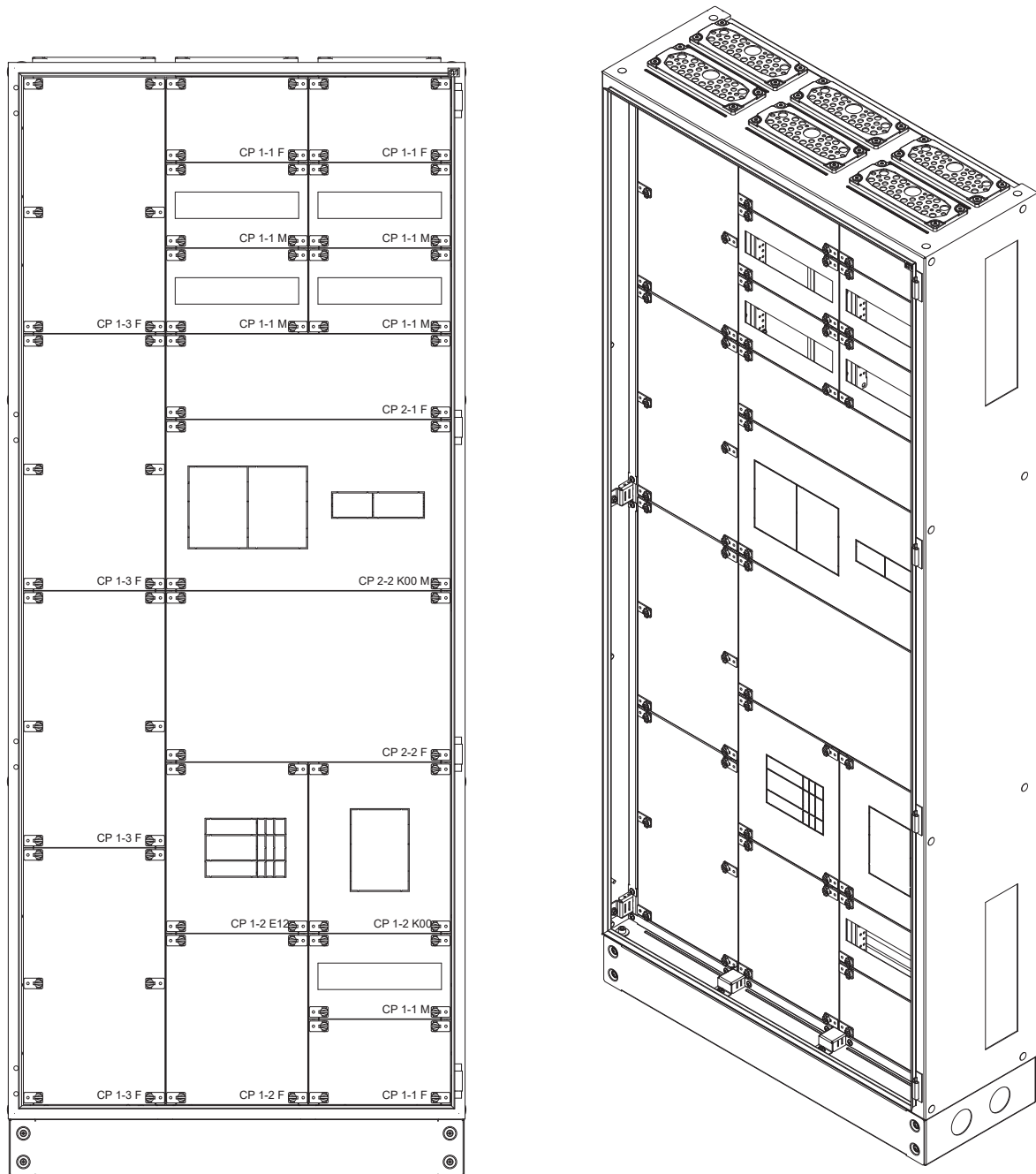

Elevation view and isometric view of the enclosure from Example 7

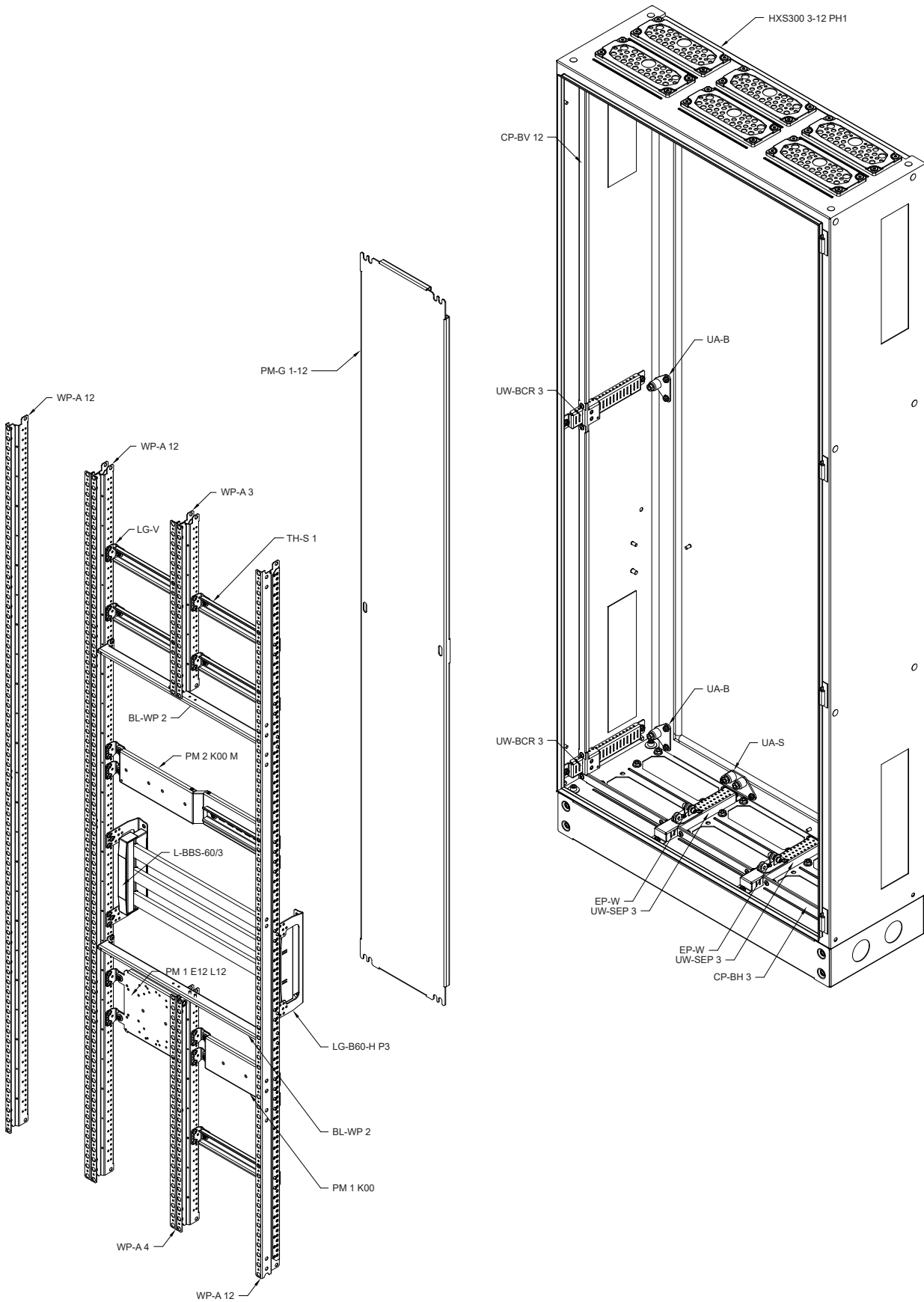

View of the decomposed enclosure from example 7

List of elements for enclosure from example 7

No.	Type	Product name	Code no.	Quantity to order
1	HXS300 3-12 PH1	Empty standing enclosure, IP65, class I RAL7035 (800x1850x300) with 100 mm plinth	001325103	1
2	UW-BCR 3	Adjustable internal set bracket for HXS enclosures, 300 mm deep (1 set = 2 pcs)	001338206	3
3	UW-SEP 3	Dividing support for HXS enclosures with a depth of 300 mm	001338302	4
4	EP-W	Dividing element of the enclosure (1 set = 2 pcs.)	001101677	2
5	UA-B	Side bracket for PM-G plates mounted on the back of the enclosure (1 set = 2 pcs)	001338102	2
6	UA-S	Center bracket for PM-G plates and WD supports mounted on the back of the enclosure (1 set = 2 pcs)	001338104	1
7	WP-A 3	Vertical support, 2-position, type A (450) (1 set = left and right)	001101644	1
8	WP-A 4	Vertical support, 2 position type A (600) (1 set = left and right)	001101646	1
9	WP-A 12	Vertical support, 2-position, type A (1800) (1 set = left and right)	001338605	2
10	BL-WP 2	Dividing bar width 2 (500) division 1: 1	001338900	2
11	LG-V SET	Fixing element (1 set = 2 pcs)	001101683	11
12	TH-S 1	Steel mounting rail 35/15 1.5 215 mm (250)	002911040	5
13	PM 2 K00 M	Cover 2xKVL00 and 9 mod. (500x300)	001340502	1
14	PM 1 E12 L12	Mounting plate 1xEB2 / ED2 125,160,250A 3,4P or 1xLA1,2 (250)	001101584	1
15	PM 1 K00	Mounting plate 1xKVL00 (250)	001340550	1
16	PM-G 1-12	Mounting plate with a height of 12 (1800) and width 1 (250)	001337963	1
17	LG-B60-H P3	Bracket with 3-pole BBS carrier	001341651	2
18	L-BBS-60/3	Side insulation cover for 3-pin BBS carrier	001696006	2
19	CP 1-1 F	Full cover (250x150)	001101429	3
20	CP 2-1 F	Full cover (500x150)	001101431	1
21	CP 1-1 M	Modular cover 12 mod. (250x150)	001101451	5
22	CP 2-2 K00 M	Cover 2xKVL00 and 9 mod. (500x300)	001339452	1
23	CP 2-2 F	Full cover (500x300)	001101438	1
24	CP 1-2 E12	Cover 1xEB2 / ED2 125.160.250A 3.4P (250x300)	001101514	1
25	CP 1-2 K00	Cover 1xKVL00 (250x300)	001339500	1
26	CP 1-2 F	Full cover (250x300)	001101436	1
27	CP 1-3 F	Full cover (250x450)	001101443	4
28	CP-BV 12	Side vertical additional covers, side, left and right, for HXS enclosures, height 12 (1800) (1 set)	001340164	1
29	CP-BH 3	Divided horizontal additional covers, upper and lower, for HXS enclosures, width 3 (750) (1 set)	001340201	1

REMEMBER!

- In order to mount the PM-G in empty HXS enclosures, the UA-B brackets should be purchased, and if the plate width is smaller than the width of the enclosure, the UA-S handles should be additionally purchased.
- BL-UA stiffening bars provide additional support points for PM-G mounting plates.
- When dividing the internal set, attention should be paid to maintaining adequate insulation distances between the electrical equipment and the components, especially the distance to the BL-WP dividing bar. The bar can be turned over by 180° and assembled depending on needs from the top or bottom of the WP-A vertical support .

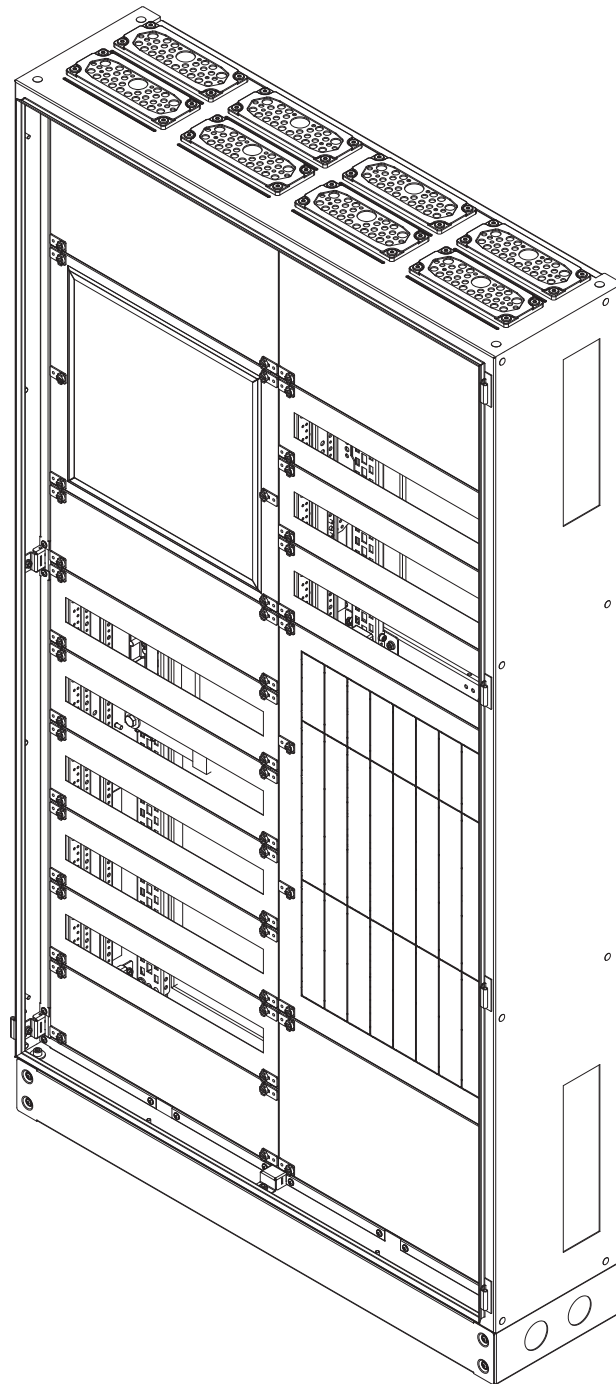

Isometric view of the enclosure from Example 8

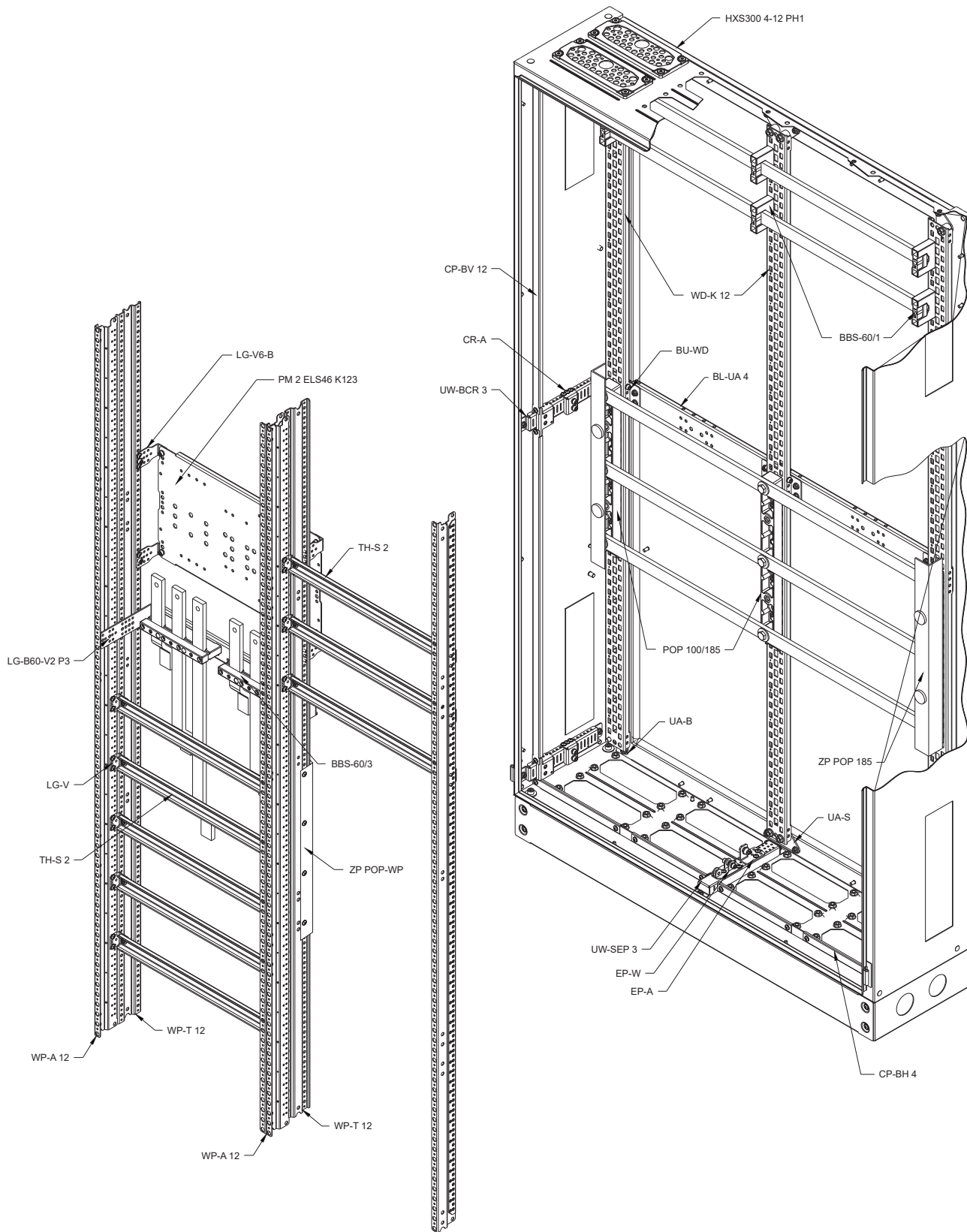

View of the decomposed enclosure from example 7

List of elements for enclosure HXS300 4-12 PH1 from example 8

No.	Type	Product name	Code no.	Quantity to order
1	HXS300 4-12 PH1	Empty enclosure, IP55, class I RAL7035 (1050x1850x300) with 100 mm plinth	001325104	1
2	WP-A 12	Vertical support, 2-position, type A (1800) (1 set = left and right)	001338605	2
3	WP-T 12	Vertical reinforced bracket type T (1800) (1 set = 2 pcs)	001338764	1
4	WD-K 12	Vertical support type K for cage nuts (1800) (1 piece)	001338864	3
5	UW-BCR 3	Adjustable internal set bracket for HXS enclosures, 300 mm deep (1 set = 2 pcs)	001338206	3
6	UW-SEP 3	Dividing support for HXS enclosures with a depth of 300 mm	001338302	2
7	EP-W	Dividing element of the enclosure (1 set = 2 pcs.)	001101677	1
8	EP-A	Dividing element for mounting the WP-T support on the UW-SEP element (1 set = 2 pcs.)	001338306	1
9	UA-S	Center bracket for PM-G plates and WD supports mounted on the back of the enclosure (1 set = 2 pcs)	001338104	1
10	UA-B	Side bracket for PM-G plates mounted on the back of the enclosure (1 set = 2 pcs)	001338102	2
11	BL-UA 4	Stiffening bar mounted directly to the enclosure, width 4 (1000) (1 set)	001338132	1
12	BU-WD	Bracket for WD supports, fixed to a stiffening bar (1 set = 2 pcs)	001338161	2
13	CR-A	Leading element to UW-BCR without the possibility of screwing covers (1 set = 2 pcs)	001338215	3
14	LG-V SET	Fixing element (1 set = 2 pcs)	001101683	8
15	LG-V6-B SET	Fixing element with M6 nut type V6-B (1 set = 2 pcs)	001341151	3
16	PM 2 ELS46 K123	Mounting plate 2xEB2 / ED2 / LA 400, 630A 3,4P or 2xLBS 400, 630A 3P or 1xLBS 400, 630A 4P or 2xKVL1,2 or 1xKVL3 (500)	001340702	1
17	TH-S 2	Steel mounting rail 35/15 1.5 465 mm (500)	002911042	8
18	LG-B60-V2 P3	Support with 3-pole BBS carrier, width 2 (500)	001341702	1
19	BBS-60/1	Insulating busbar carrier, 1-pole	001696000	6
20	BBS-60/3	Insulation carrier for busbars with a thickness of 5 or 10 mm, 3-pole	001696001	1
21	POP 100/185	Insulation carrier for busbars with a spacing of 100 and 185 mm	001691055	3
22	ZP POP 185	Side insulation cover for POP 100/185 carrier, for busbars with 185 mm spacing	001691057	2
23	ZP POP-WP	Insulating cover for mounting between vertical supports and 100/185 mm busbar system	001342180	1
24	CP 2-1 F	Full cover (500x150)	001101431	2
25	CP 2-2 F	Full cover (500x300)	001101438	3
26	CP 2-3 PF	Universal cover with plastic filling (500x450)	001340058	1
27	CP 2-1 M	Modular cover 24 mod. (500x150)	001101453	8
28	CP 2-5 SL	Cover 8xSL00 or 4xSL1,2,3 (500x750)	001339752	1
29	CP-BV 12	Side additional covers, side, left and right, for HXS enclosures, height 12 (1800) (1 set)	001340164	1
30	CP-BH 4	Divided horizontal additional covers, upper and lower, for HXS enclosures, width 4 (1000) (1 set)	001340202	1
31	AS-SH 6x35 SET	Metric Allen screw - M6 (1 set = 10 pcs.)	001343415	2
32	AS-SH 8x16 SET	Metric Allen screw - M8 (1 set = 10 pcs.)	001343421	1
33	AN-KFH 8x13 M6	M6 cage nut inserted from the front to the 8 x 13 mm hole	001343730	12
34	AN-KFH 10.5x16.5 M8	The M8 cage nut inserted from the front to the 10.5 x 16.5 mm hole	001343731	9

REMEMBER!

- HXS 4X (1050 mm) series enclosures with double leaf doors have an IP55 protection rating.
- Dedicated UA-B-WD side brackets for WD-K vertical supports allow the installation of POP 100/185 insulating supports at any height without collision with fixing elements.
- The termination of busbars should always be secured with additional insulating covers.
- An additional BBS 60/3 carrier for the second busbar can be attached to the bracket with the LG-B60-V2 P3 isolation carrier.

Example 9. Set of two connected HXS400 3-13 enclosures with internal sets for modular equipment, EB2 / ED2 MCCB's and disconnectors, KVL disconnectors and SL strip type fuse-switch disconnectors

Set of two connected HXS400 3-13 enclosures, each with an IP65 protection, 1950 mm (without a plinth), 800 mm wide and depth 400 mm, the total width of the set is 1600 mm. In the following configuration, the enclosures are equipped with plinths with a height of 100 mm and suitable for mounting 60 modules, 5 KVL NH00 fuse-links disconnectors and 1 KVL NH1 disconnector mounted on the busbar, 2 ED2 disconnectors / EB2 MCCB's 125, 160, 250 A, 1 ED2 disconnector / EB2 MCCB 400, 630 A and 8 SL NH00 strip type fuse-switch disconnectors or 4 SL NH1,2,3 strip type fuse-switch disconnectors. The internal set ensures easy assembly and use supports with insulating carriers and busbars significantly facilitates power distribution and connection of the installed equipment. Through broken weakening in the covers of the enclosures, busbars supplying the equipment in both sections are carried out. In the enclosures WP-A vertical and WD-K supports were used, on which a 185 mm busbar was mounted for the installation of SL strip type fuse-switch disconnectors. The entire internal set is mounted on brackets that allow you to adjust its depth. The current busbars are mounted on WP-A supports and on the rear wall of the enclosure on WD-K vertical supports with BBS insulating carriers.

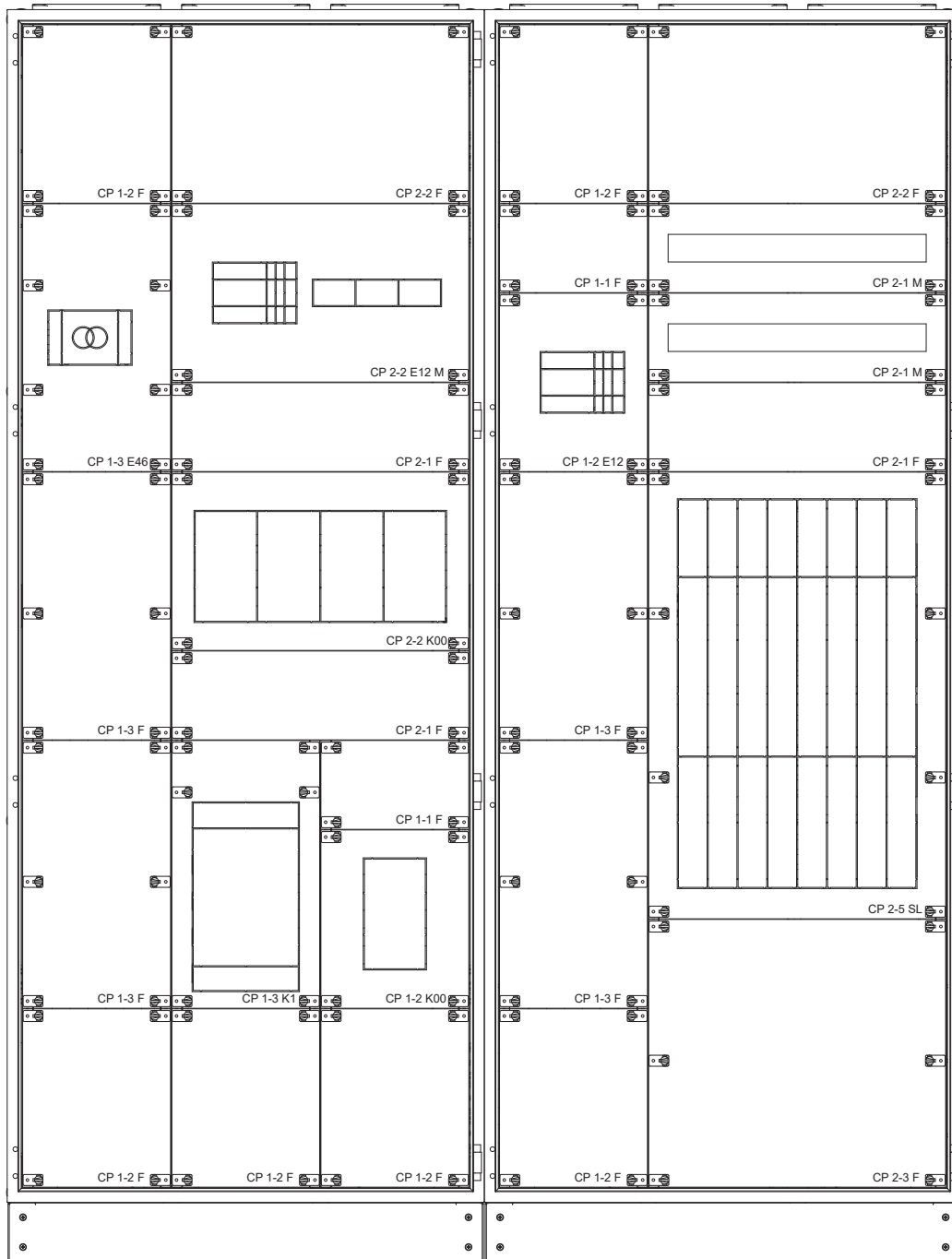

View of the elevation of the enclosure from Example 9

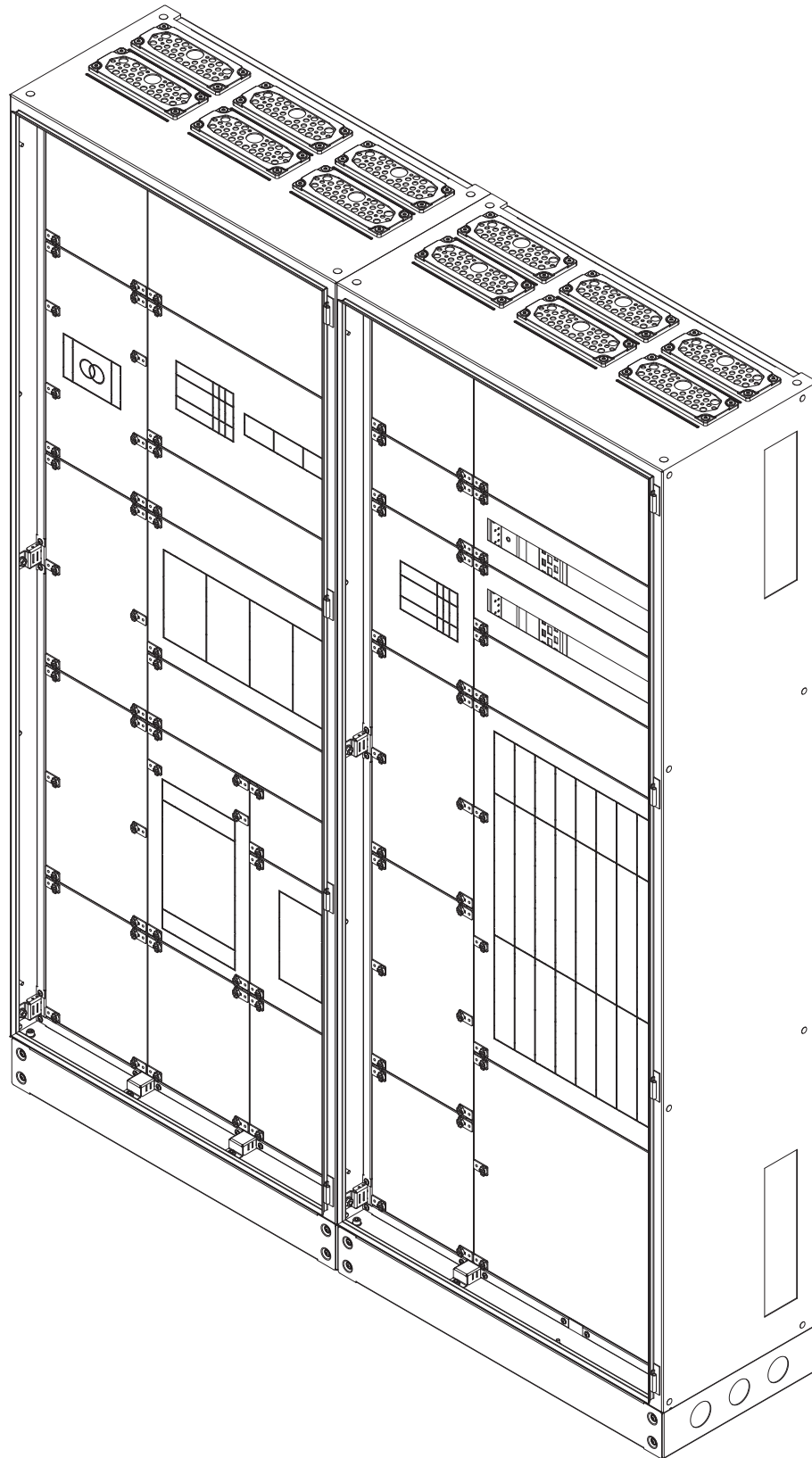

Isometric view of the enclosure from Example 9

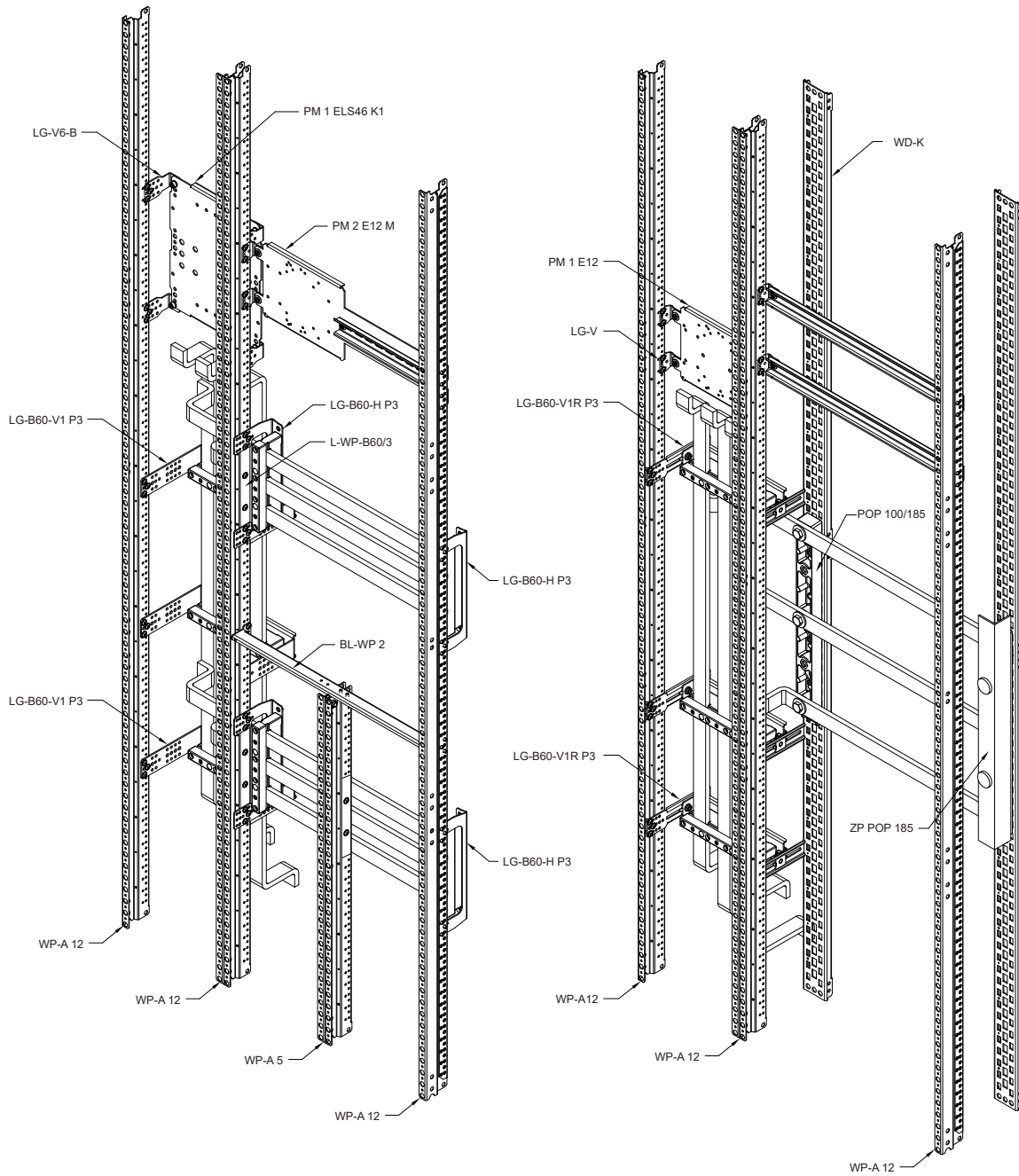

View of the decomposed enclosure from example 9

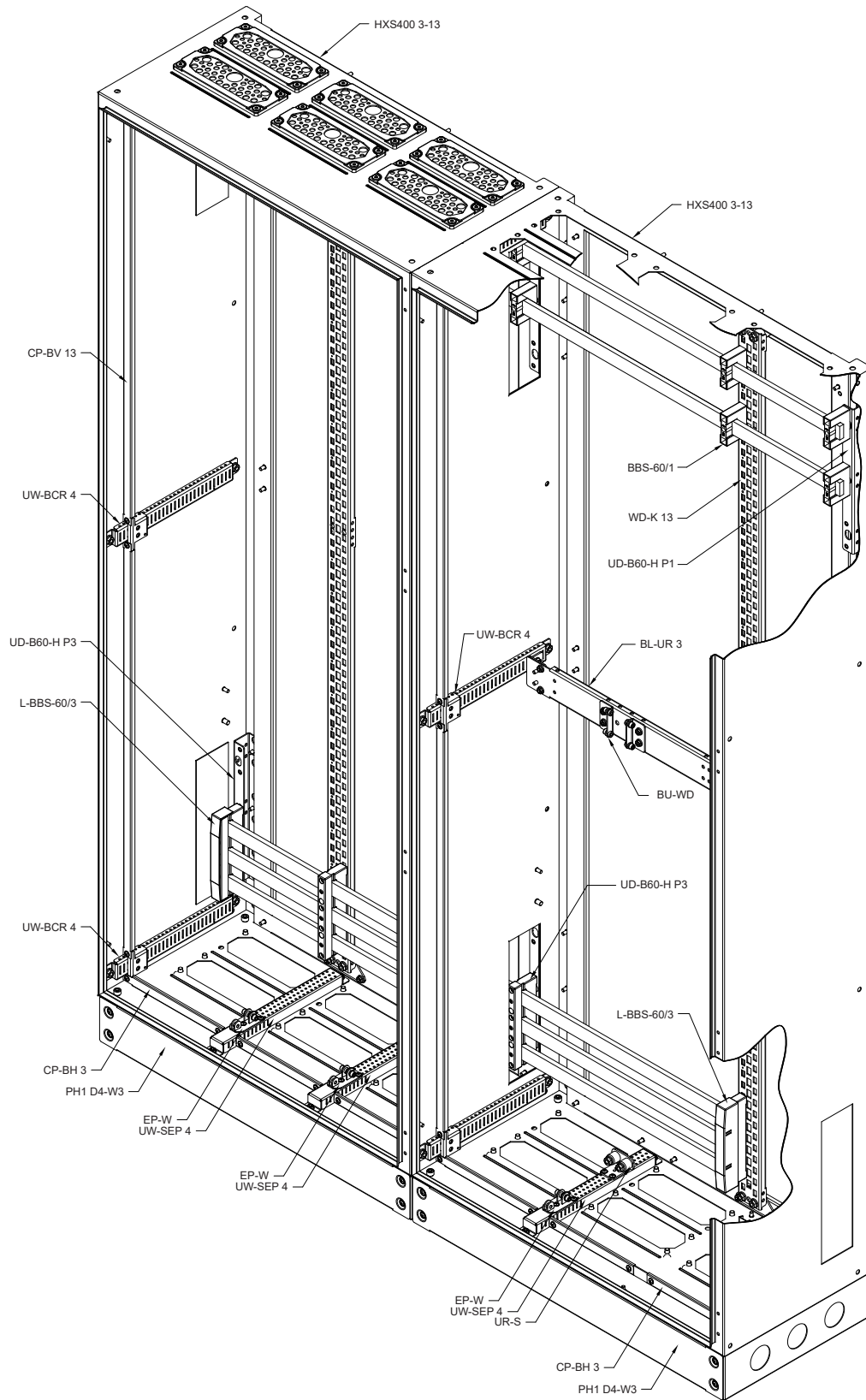

View of the decomposed enclosure from example 9

List of components for the HXS400 3-13 enclosure kit from Example 9

No.	Type	Product name	Code no.	Quantity to order
1	HXS400 3-13	Empty standing enclosure, IP65, class I RAL7035 (800x2000x400) without plinth	001327509	2
2	PH1 D4-W3	100 mm high plinth RAL 9005 for HXS400 enclosures with a width of 3 (800)	001336920	2
3	WP-A 13	Vertical support 2-position type A (1950) (1 set = left and right)	001338606	4
4	WP-A 5	Vertical support 2 position type A (750) (1 set = left and right)	001101647	1
5	WD-K 13	Vertical support type K for cage nuts (1950) (1 piece)	001338865	4
6	UW-BCR 4	Adjustable internal set bracket for HXS enclosures with a depth of 400 mm (1 set = 2 pcs)	001338207	6
7	UW-SEP 4	Dividing bracket for HXS enclosures with a depth of 400 mm	001338303	5
8	BL-WP 2	Dividing bar width 2 (500) split 1: 1	001338900	1
9	EP-W	Dividing element of the enclosure (1 set = 2 pcs.)	001101677	3
10	UA-S	Center bracket for PM-G plates and WD supports mounted on the back of the enclosure (1 set = 2 pcs)	001338104	2
11	BL-UR 3	Stiffening bar with adjustable depth, width 3 (750) (1 set)	001338146	1
12	BU-WD	Bracket for WD supports, fixed to a stiffening bar (1 set = 2 pcs)	001338161	2
13	CR-A	Leading element to UW-BCR without the possibility of screwing covers (1 set = 2 pcs)	001338215	1
14	LG-V SET	Fixing element with M5 nut (1 set = 2 pcs.)	001101683	6
15	LG-V6-B SET	Fixing element with M6 nut type V6-B (1 set = 2 pcs)	001341151	2
16	PM 1 ELS46 K1	Mounting plate 1xEB2 / ED2 / LA 400, 630A 3,4P or 1xLBS 400, 630A 3P or 1xKVL1 (250)	001340700	1
17	PM 1 E12 L12	Mounting plate 1xEB2 / ED2 125,160,250 A 3,4P or 1xLA1,2 (250)	001101584	1
18	PM 2 E12 M	1xEB2 / ED2 mounting plate with TH35 rail for 12 mod. (500)	001101572	1
19	TH-S 2	Steel mounting rail 35/15 1.5 465 mm (500)	002911042	2
20	LG-B60-V1R P3	Bracket with BBS 3-pole carrier, width 1 (250)	001341750	3
21	LG-B60-H P3	Bracket with 3-pole BBS carrier	001341651	4
22	LG-B60-V1 P3	Bracket with BBS 3-pole carrier, width 1 (250)	001341700	3
23	UD-B60-H P1	Bracket with 1-pole BBS carrier	001341800	2
24	UD-B60-H P3	Bracket with 3-pole BBS carrier	001341802	2
25	BBS-60/1	Insulating busbar carrier, 1-pole	001696000	6
26	BBS-60/3	Insulation carrier for busbars with a thickness of 5 or 10 mm, 3-pole	001696001	2
27	L-BBS-60/3	Side insulation cover for 3-pole BBS carrier	001696006	4
28	L-WP-B60/3	3-pole Insulating cover, for mounting on vertical supports, providing insulation from busbars	001342181	3
29	BBC-1/30	Insulating cover for a single busbar, for 30 mm wide rails and thickness of 5 or 10 mm, length 1 m	001696012	1
30	POP 100/185	Insulation carrier for busbars with a spacing of 100 and 185 mm	001691055	2
31	ZP POP 185	Side insulation cover for POP 100/185 carrier, for busbars with 185 mm spacing	001691057	1
32	CP 1-1 F	Full cover (250x150)	001101429	2
33	CP 1-2 F	Full cover (250x300)	001101436	6
34	CP 1-3 F	Full cover (250x450)	001101443	4
35	CP 2-1 F	Full cover (500x150)	001101431	3
36	CP 2-2 F	Full cover (500x300)	001101438	2
37	CP 2-3 F	Full cover (500x450)	001101444	1
38	CP 1-3 E46	Cover 1xEB2 / ED2 400, 630A 3,4P (250x450)	001339300	1
39	CP 1-3 K1	Cover 1xKVL1 (250x450)	001339550	1
40	CP 1-2 K00	Cover 1xKVL00 (250x300)	001339500	1
41	CP 2-2 K00	Cover 4xKVL00 (500x300)	001339502	1
42	CP 2-2 E12 M	Cover 1xEB2 / ED2 125,160,250A 3,4P and 12 mod. (500x300)	001101483	1
43	CP 1-2 E12	Cover 1xEB2 / ED2 125.160.250A 3.4P (250x300)	001101514	1
44	CP 2-1 M	Modular cover 24 mod. (500x150)	001101453	2
45	CP 2-5 SL	Cover 8xSL00 or 4xSL1,2,3 (500x750)	001339752	1
46	CP-BV 13	Side vertical additional covers, side, left and right, for HXS enclosures, height 13 (1950) (1 set)	001340165	2
47	CP-BH 3	Divided horizontal additional covers, upper and lower, for HXS enclosures, width 3 (750) (1 set)	001340201	2
48	ZL-GXA-SEAL	Kit for connecting the enclosures (1 set)	001342651	1
49	AS-SH 6x35 SET	Metric Allen screw - M6 (1 set = 10 pcs.)	001343415	2
50	AS-SH 8x16 SET	Metric Allen screw - M8 (1 set = 10 pcs.)	001343421	1
51	AN-KFH 8x13 M6	M6 cage nut inserted from the front to the 8 x 13 mm hole	001343730	10
52	AN-KFH 10.5x16.5 M8	The M8 cage nut inserted from the front to the 10.5 x 16.5 mm hole	001343731	1



ETI Elektroelement d.o.o

Obresija5, 1411 Izlake,
Slovenia

Tel: +386 (0) 3 56 57 570

Fax: +386 (0) 3 56 74 077

eti@eti.si