

Rastalni ulošci D

Tehnički podaci	
Nazivni napon U_n	500 V a.c. / 400 V d.c., 600V a.c., 750V a.c., 1200V a.c.
Nazivna struja I_n	DI, DII 2 - 25 A, DIII 32 - 63 A DIV 80 - 100 A, DV 125 - 200 A
Nazivna isklopna moć kod 1,1 U_n	50 kA a.c. $\cos \rho = 0,2$ 8 kA d.c. $T=15 \text{ ms}$
Karakteristika taljenja	gG, TDZ, DZ, gF
Razred izolacije	C - VDE 0110
Standard	DIN EN 60269-1, IEC 60269-1:2005-04 (VDE 0636 Teil 10): 1999-11 DIN EN 60269-3, IEC 60269-3:2003 (VDE 0636 Teil 30): 1995-12 DIN EN 60269-3-1, IEC 60269-3-1: 2004-07 (VDE 0636 Teil 301): 1998-01 DIN VDE 0635/02.84

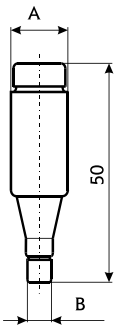

DI za osnovu E 16		
I_n [A]	dimenzije	
	$\varnothing A$	$\varnothing B$
2	13,2	6
4	13,2	6
6	13,2	6
10	13,2	8
16	13,2	10
20	13,2	12
25	13,2	14

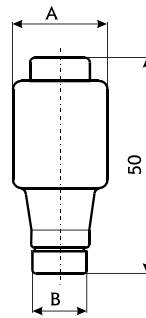

DII za osnovu E 27		
I_n [A]	dimenzije	
	$\varnothing A$	$\varnothing B$
2	21,5	6
4	21,5	6
6	21,5	6
10	21,5	8
13	21,5	8
16	21,5	10
20	21,5	12
25	21,5	14

DIII za osnovu E 33		
I_n [A]	dimenzije	
	$\varnothing A$	$\varnothing B$
32	27	16
35	27	16
40	27	16
50	27	18
63	27	20

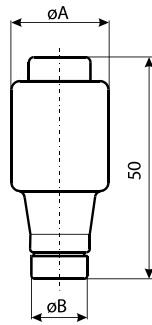

DIV za osnovu R1 1/4"		
I_n [A]	dimenzije	
	$\varnothing A$	$\varnothing B$
80	33	5
100	33	7

DV za osnovu R 2"		
I_n [A]	dimenzije	
	$\varnothing A$	$\varnothing B$
125	46	5
160	46	7
200	46	9

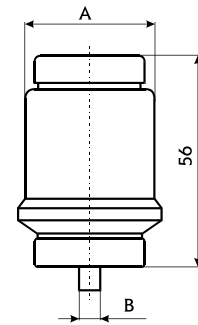

DIII gG, 690 V a.c., 600 V d.c.		
I_n [A]	dimenzije	
	$\varnothing A$	$\varnothing B$
2	27	6
4	27	6
6	27	6
10	27	8
16	27	10
20	27	12
25	27	14
35	27	16
50	27	18
63	27	20

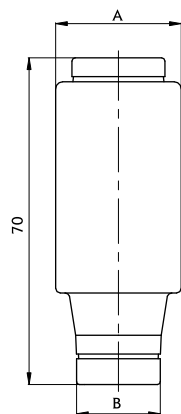

DIII gF, 750 V a.c., 1200 V a.c.		
I_n [A]	dimenzije	
	$\varnothing A$	$\varnothing B$
2	27	6
4	27	6
6	27	6
10	27	8
16	27	10
20	27	12
25	27	14
35	27	16

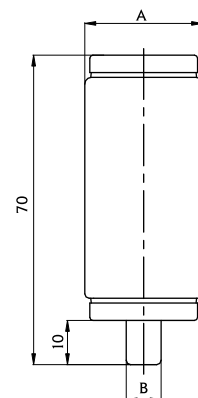

Tehnički podaci - D

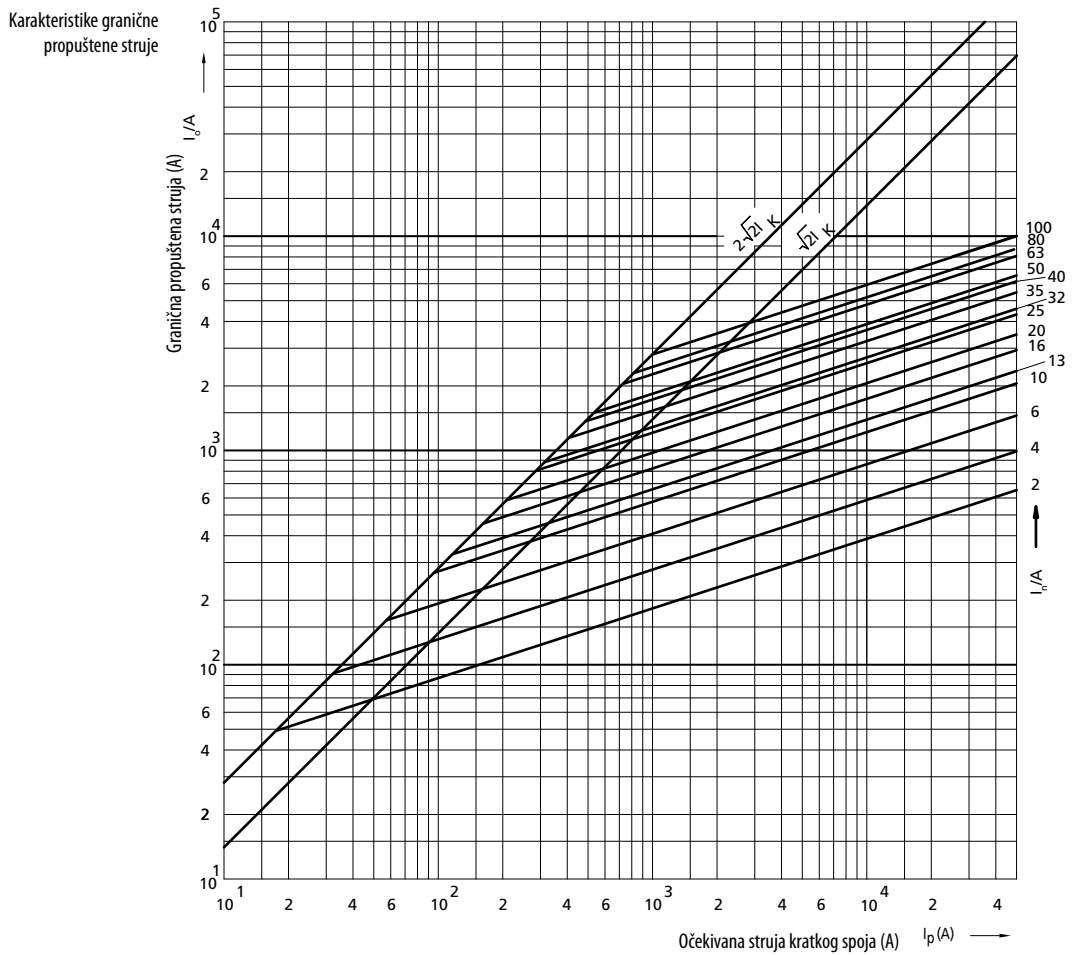
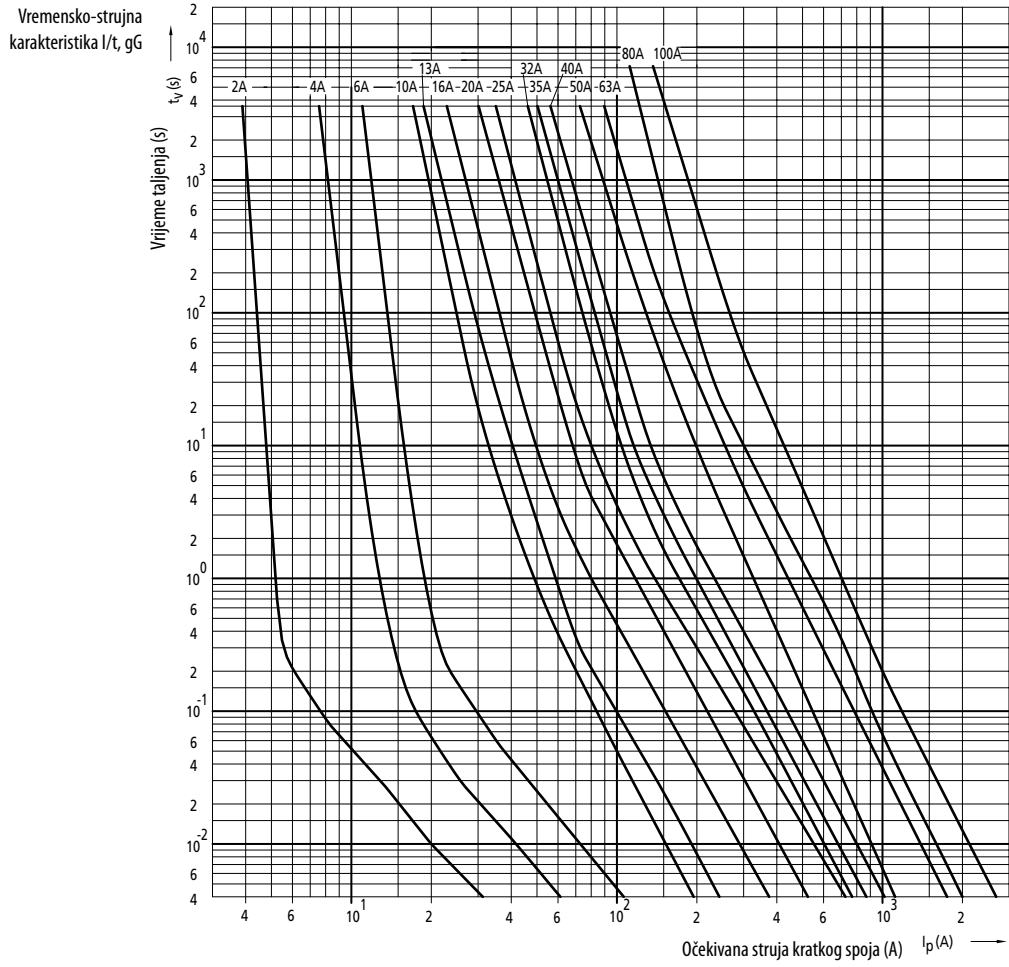
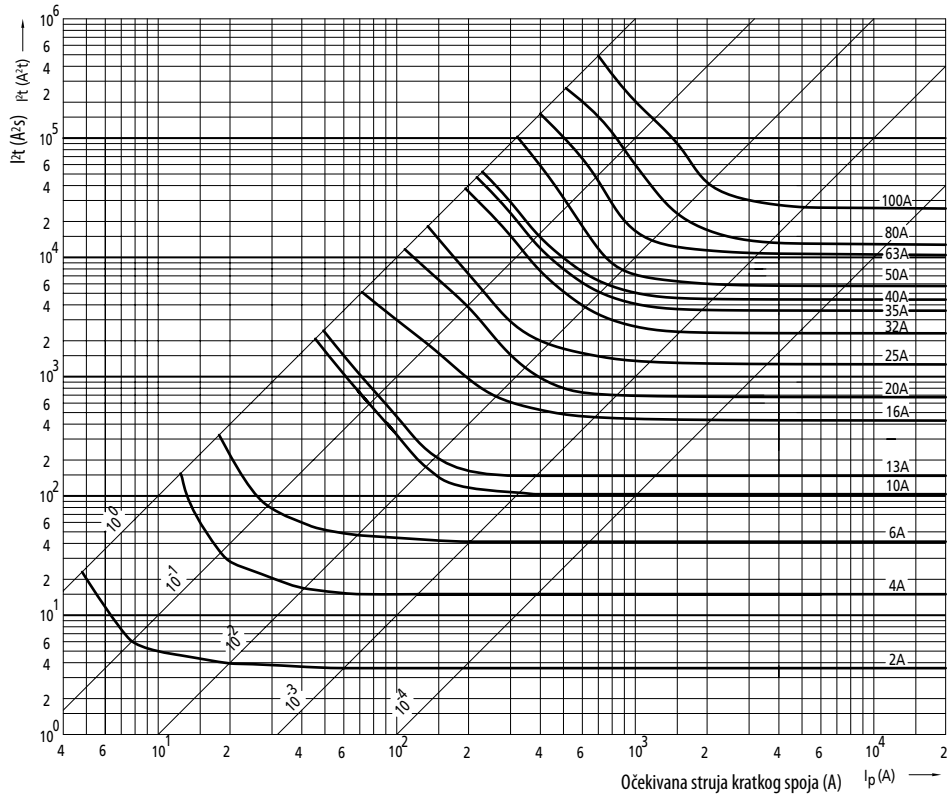
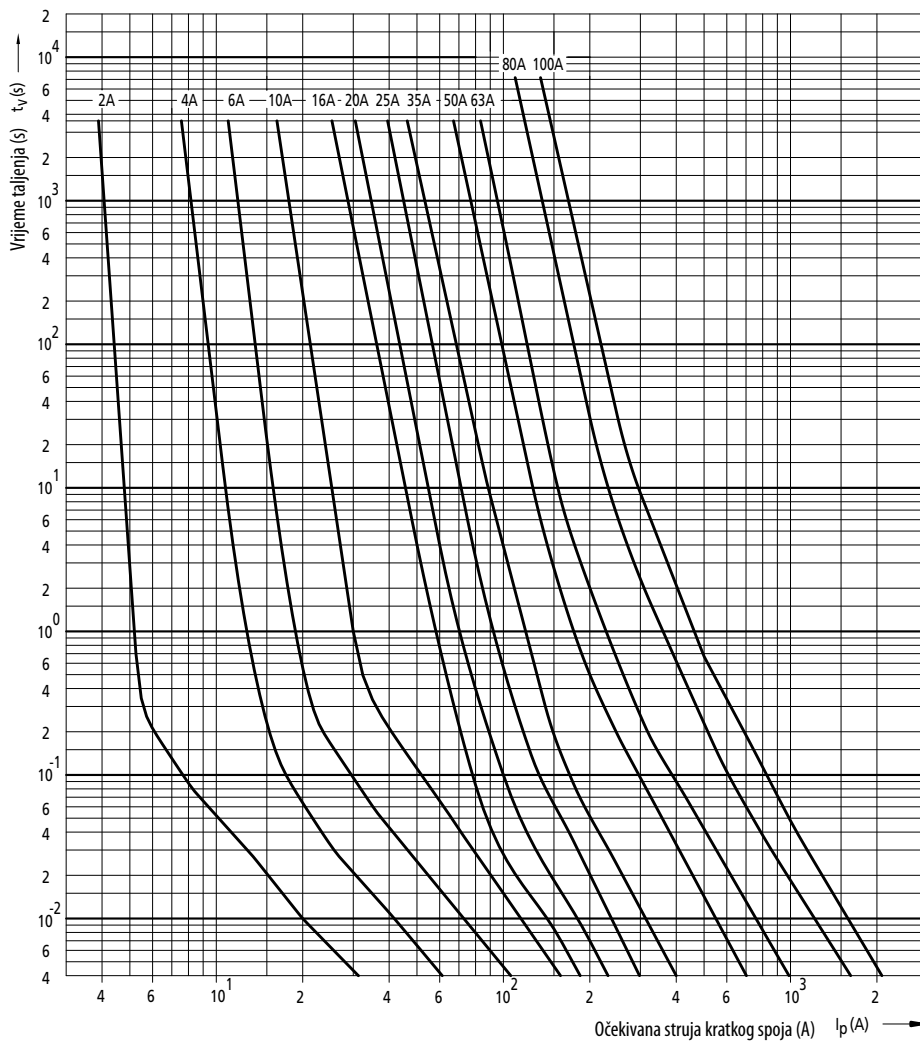

Diagram I_tt karakteristika



Vremensko-strujna karakteristika I/t DZ



1-polne osnove

Tehnički podaci:

Nazivni napon U_n	500 V, 690 V
Nazivna struja I_n	DII 25 A, DIII 63 A
Razred izolacije	u skladu s IEC 60664-1
Presjek priključnih vodiča	DII 1 do 10 mm ² DIII 2,5 do 25 mm ²
Standard	IEC 60269, EN 60269, DIN VDE 0636

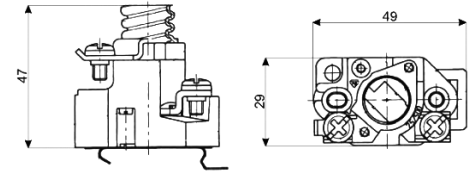

Osnove osigurača DI

Osnove osigurača EZ

tip	I_n [A]	dimenzije						
		A	B	C	D	E	F	G
EZ	25	41	47	36	20	35	13	46
EZ	63	45	56	45	20	36	14	58

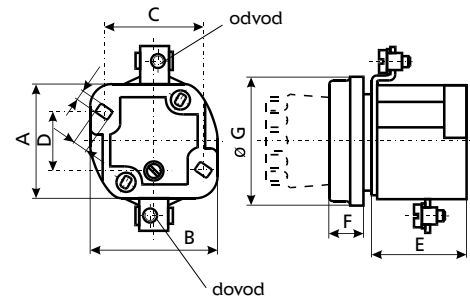

Osnove osigurača TZ

tip	I_n [A]	dimenzije						
		A	B	C	D	E	F	G
TZ	25	26	50	53	13,5	14	M	46
TZ	63	31	58	64	16	18	M	58

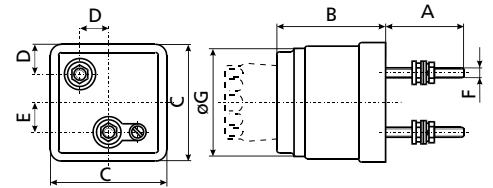

Osnove osigurača UZ, UZN

tip	I_n [A]	dimenzije							
		A	B	C	D	E	F	H	I
UZ	25	56	80	41	33	82	20	4,5	4,5
UZN	25	56	80	41	33	82	20	4,5	4,5
UZ	63	56	90	52	41	82	28	4,5	4,5
UZN	63	56	90	52	41	82	28	4,5	4,5

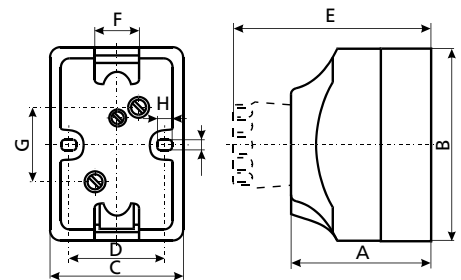

Osnove osigurača EZR

tip	I_n [A]	dimenzije			
		A	B	C	D
EZR	25	42	46	45	35
EZR	63	47	58	48,5	38

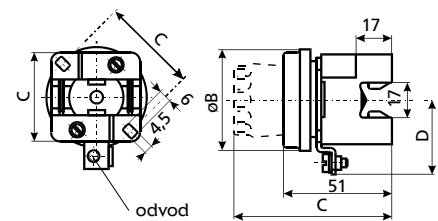

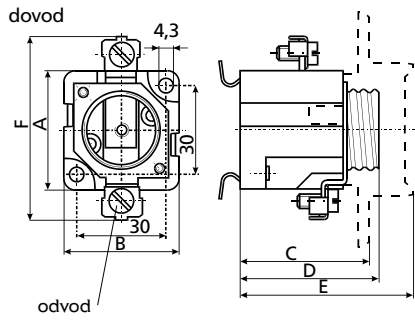

Osnove osigurača EZN, EZV

tip	I _n [A]	dimenzije					
		A	B	C	D	E	F
EZN 25°	25	41	39	44	47	60	62
EZN 63°	63	43	47	44	47	56	79
EZN 63-M6°	63	43	47	44	47	56	79
EZV 25	25	41	39	44	47	60	62
EZV 63	63	43	47	44	47	56	79
EZV 63-M6	63	43	47	44	47	56	79
EZN 25-ZP*	25	41	39	44	47	60	62
EZN 63-ZP*	63	43	47	44	47	56	79
EZV 25-ZP*	25	41	39	44	47	60	62
EZV 63-ZP*	63	43	47	44	47	56	79

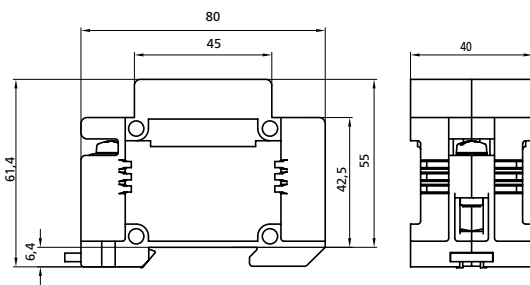

Osnove osigurača D Comfort

Nazivni napon U _n	500 V
Nazivna struja I _n	25 A
Za rastalne uloške tipa DII	u skladu s IEC/EN 60269-3
Kalibarski prstenovi VDII	u skladu s IEC/EN 60269-3
Presjek priključnih vodiča	1,5 - 25 mm ²
Vijci	sa ±glavom
Mogućnost montaže::	- sa vijcima - montaža na letvu i EN 60715

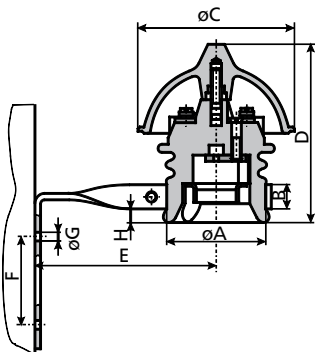

Osnova osigurača za zračne vodove

tip	I _n [A]	dimenzije							
		ØA	B	ØC	D	E	F	ØG	H
FZ	25	61	14	104	118	90	50	7	20
FZ	65	70	21	114	120	130	58	7	21

3-polne osnove

Osnove osigurača EZN/3, EZV/3 - linijski

tip	dimenzije							
	A	B	C	D	E	F	ØG	H
EZN 25/3	41	121	44	47	60	30	4,3	50
EZN 25/3	41	121	44	47	60	30	4,3	50
EZN 63/3	43	148	44	47	56	32	4,3	62
EZN 63/3	43	148	44	47	56	32	4,3	62

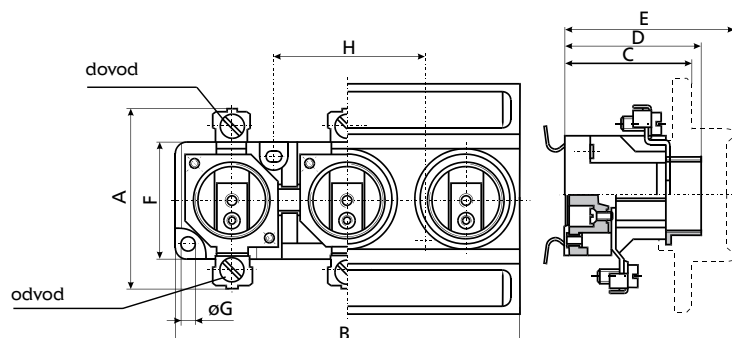

Tehnički podaci - D

Osnove osigurača EZN/3, EZV/3 - DELTA

tip	dimenzije							
	A	B	C	D	E	F	G	H
EZN 25/3	106	106	48	/	/	45	52	86
EZV 25/3	106	106	48	32	5,2	45	52	86
EZN 63/3	127	130	54	/	/	45	52	85
EZV 63/3	127	130	54	32	5,2	45	52	85

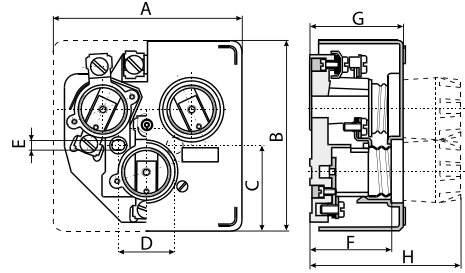

Tarifni osigurač

tip	dimenzije								
	A	B	C	D	E	F	G	H	I
T 25/3N	106	106	48	/	/	45	52	86	97
T 63/3N	127	130	54	/	/	45	52	85	97
T 25/3V	106	106	48	32	5,2	45	52	86	97
T 63/3V	127	130	54	32	5,2	45	52	85	97

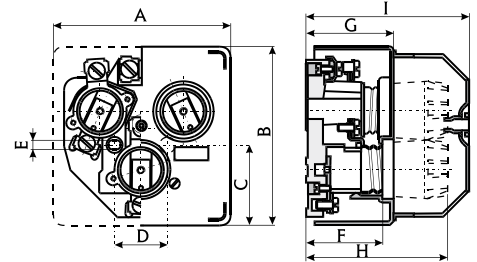

Kalibarski prstenovi

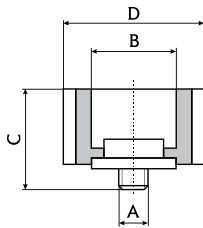

VD II za osnovu E 27

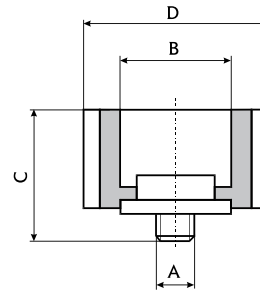

VD III za osnovu E33

VD II za osnovu E 27

I _n [A]	dimenzije			
	A	B	C	D
2	3/16"	6,5	17	24
4	3/16"	6,5	17	24
6	3/16"	6,5	17	24
10	3/16"	8,5	17	24
16	3/16"	10,5	17	24
20	3/16"	12,5	17	24
25	3/16"	14,5	17	24

VD III za osnovu E 33

I _n [A]	dimenzije			
	A	B	C	D
35	3/16"	16,5	17	30
50	3/16"	18,5	17	30
63	3/16"	20,5	17	30

Kapa osigurača D

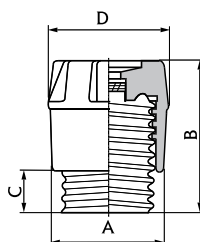

Kapa osigurača

tip	dimenzije			
	A	B	C	D
KDI	23	35	10	26
KDII	34	44	12	35
KDIII	43	44	12	43

Zaštitni poklopac

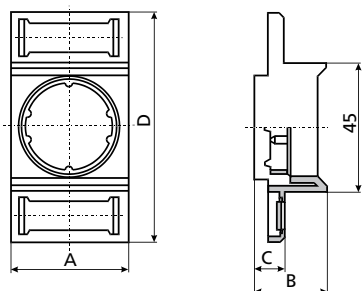

1-polni zaštitni poklopac

tip	I _n [A]	dimenzije			
		A	B	C	D
EZN, EZV	25	40	24	10,8	80
EZN, EZV	63	49	21	9	80

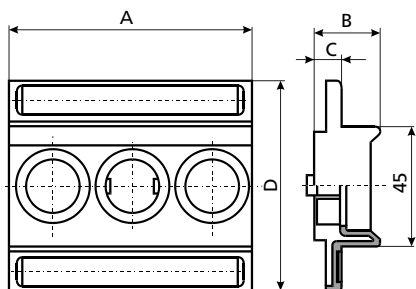

3-polni zaštitni poklopac

tip	dimenzije			
	A	B	C	D
EZN, EZV 25/3	121	24	10,8	80
EZN, EZV 63/3	148	21	9	80

Sabirnice za 1 - polnu osnovu EZR

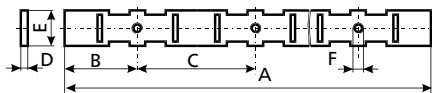

Sabirnica za osnovu osigurača EZR

tip	I _n [A]	dimenzije					
		A	B	C	D	E	F
EZR	25	1000	32	52	3	16	3/16"
EZR	63	1000	38	62	3	16	3/16"

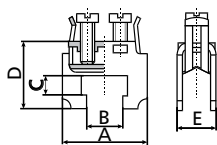

Stezaljka za nul sabirnice i sabirnice EZR

za presek [mm ²]	dimenzije				
	A	B	C	D	E
16	25	12,5	3,5	17	7,3
35	28	12,5	6,5	21,5	12,6